

# TAURUS®

## Assembly and Operating Instructions

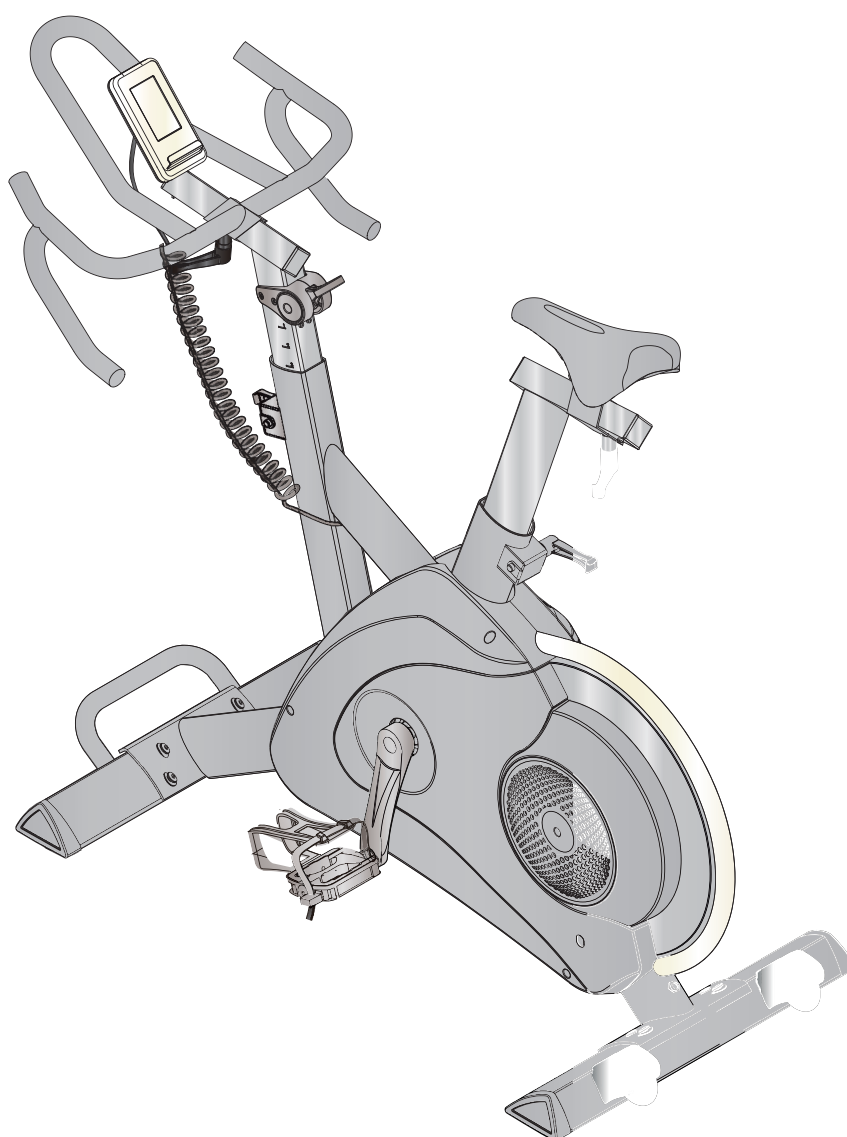

max. 150 kg



~ 60 Min.



55 kg

L 143 | W 56 | H 124

TFZ9PRO.01.07

Art. No. TF-Z9PRO

Indoor Cycle Z9PRO



# Content

<b>1</b>	<b>GENERAL INFORMATION</b>	<b>8</b>
1.1	Technical Data	8
1.2	Personal Safety	9
1.3	Electrical Safety	10
1.4	Set-Up Place	11
<b>2</b>	<b>ASSEMBLY</b>	<b>12</b>
2.1	General Instructions	12
2.2	Scope of Delivery	13
2.3	Assembly	14
2.4	Equipment settings	20
2.4.1	Emergency brake	20
2.4.2	Saddle	21
2.4.3	Handlebars	22
<b>3</b>	<b>OPERATING INSTRUCTIONS</b>	<b>23</b>
3.1	Console Display	23
3.2	Button functions	24
3.3	Turning on and setting up the Indoor Cycle	25
3.4	Programs	25
3.4.1	Quick Start program	25
3.4.2	Target program (Manual)	26
3.4.3	Pre-set programs - Beginner	27
3.4.4	Pre-set programs - Advance	28
3.4.5	Pre-set programs - Sporty	29
3.4.6	Heart rate controlled programs	30
3.4.7	Watt controlled programs	31
3.4.8	Recovery program	32
3.5	Wireless Connection and Fitness Apps	33
<b>4</b>	<b>STORAGE AND TRANSPORT</b>	<b>34</b>
4.1	General Instructions	34
4.2	Transportation Wheels	34
<b>5</b>	<b>TROUBLESHOOTING, CARE AND MAINTENANCE</b>	<b>35</b>
5.1	General Instructions	35
5.2	Faults and Fault Diagnosis	35
5.3	Error Codes and Troubleshooting	36
5.4	Maintenance and Inspection Calendar	37
<b>6</b>	<b>DISPOSAL</b>	<b>37</b>

<b>7</b>	<b>RECOMMENDED ACCESSORIES</b>	<b>38</b>
<b>8</b>	<b>ORDERING SPARE PARTS</b>	<b>39</b>
8.1	Serial Number and Model Name	39
8.2	Parts List	40
8.3	Exploded Drawing	44
<b>9</b>	<b>WARRANTY</b>	<b>45</b>
<b>10</b>	<b>CONTACT</b>	<b>47</b>

**Dear customer,**

Thank you for choosing a high-quality equipment of the brand TAURUS®. TAURUS® offers sports and fitness equipment for the sophisticated home sport and the equipment of fitness studios and business customers. With TAURUS® fitness equipment, the focus is on what sport is all about: maximum performance! Therefore, the equipment is developed in close consultation with athletes and sports scientists. Because athletes know best what makes perfect fitness equipment.

Further information can be found at [www.fitshop.com](http://www.fitshop.com).

**Intended Use**

The equipment may only be used for its intended purpose.

The equipment is suitable for home use and semi-professional use (e.g. hospitals, clubs, hotels, schools, etc.). The equipment is not suitable for commercial or professional use (e.g. fitness studio).

**Legal Notice**

Fitshop GmbH  
Europe's No. 1 for home fitness

International Headquarters  
Flensburger Straße 55  
24837 Schleswig  
Germany

Management:  
Christian Grau  
Sebastian Campmann  
Dr. Bernhard Schenkel  
No. HRB 1000 SL  
Local Court Flensburg  
European VAT Number: DE813211547

**Disclaimer**

© TAURUS is a registered brand of the company Fitshop GmbH. All rights reserved. Any use of this trademark without the explicit written permission of Fitshop is prohibited.

Product and manual are subject to change. Technical data can be changed without advance notice.

**FITSHOP**

Europe's No.1 for Home Fitness

## ABOUT THIS MANUAL

Please carefully read the entire manual before installation and first use. The manual will help you to quickly set up the system and explains how to safely use it. Make sure that all persons exercising with the equipment (especially children and persons with physical, sensory, mental or motor disabilities) are informed about this manual and its contents in advance. In case of doubt, responsible persons must supervise the use of the equipment.



Due to ongoing changes and software optimisations, the manual may have to be updated. If you notice any discrepancies during assembly or use, please refer to the manual uploaded to the webshop. The latest manual is always available there.

This equipment has been manufactured according to the latest safety knowledge. As far as possible, potential safety hazards which could cause injury have been eliminated. Make sure to carefully follow the instructions and that all parts are securely in place. If required, read through the instructions again to correct any mistakes.

Training devices must be classified according to accuracy and use. Accuracy classes are only applicable to devices that display training data.

### Accuracy classes

Class A: high accuracy.

Class B: medium accuracy.

Class C: low accuracy.

The use classes explain the intended use of the training device.

### Use classes

**Class S** (studio): professional and/or commercial use.

These training devices are intended for the use in training rooms of facilities such as sports clubs, school facilities, hotels, clubs and studios whose access and supervision is specifically regulated by the owner (person with legal responsibility).

**Class H** (home use): use at home.

These stationary training devices are intended for the use in private homes where access to the training device is regulated by the owner (person with legal responsibility).

Please pay close attention to the safety and maintenance instructions given here. The contract partner cannot be held liable for damage to health, accidents or damage to the equipment when it is not used in accordance with these instructions.

The following safety instructions may appear in this manual:

► **ATTENTION**

This notice indicates potentially hazardous situations which, if not avoided, may result in property damage.

⚠ **CAUTION**

This notice indicates potentially hazardous situations which, if not avoided, may result in slight or minor injuries!

⚠ **WARNING**

This notice indicates potentially hazardous situations which, if not avoided, may result in death or serious injuries!

⚠ **DANGER**

This notice indicates potentially hazardous situations which, if not avoided, will result in death or serious injuries!

ⓘ **NOTICE**

This notice indicates further useful information.

Retain these instructions in a safe place for future reference, maintenance or when ordering replacement parts.

## 1.1 Technical Data

### LCD - Data displayed

- + Speed in km/h
- + Training time in min
- + Training distance in km
- + RPM (Revolutions per Minute)
- + Calories burned
- + Heart rate (in conjunction with a chest strap)
- + Watts

Training programs in total:	19
Quick start programs:	1
Target programs:	1
Pre-set programs:	12
Heart rate programs:	4
Watt programs:	1
Recovery programs:	1

Brake system:	electronically adjustable magnetic brake
Performance:	10-350 W (adjustable in 5 Watt increments)
Resistance levels:	32
Flywheel mass:	17kg
Transfer ratio:	1:6.5
Crank length:	17cm

### Weight and dimensions

Article weight (gross, incl. packaging):	61kg
Article weight (net, without packaging):	55kg

Assembled dimensions (L x B x H):	approx. 143cm x 56cm x 124cm
Packed dimensions (L x B x H):	approx. 117cm x 26cm x 92cm

Maximum user weight:	150kg
Use class:	S



## 1.2 Personal Safety

### **DANGER**

- + Before you start using the equipment, you should consult your physician that this type of exercise is suitable for you from a health perspective. Particularly affected are persons who: have a hereditary disposition to high blood pressure or heart disease, are over the age of 45, smoke, have high cholesterol values, are overweight and/or have not exercised regularly in the past year. If you are under medical treatment that affects your heart rate, medical advice is absolutely essential.
- + Note that excessive training can seriously endanger your health. Please also note that heart rate monitoring systems can be inaccurate. If you notice any signs of weakness, nausea, dizziness, pain, shortness of breath, or other abnormal symptoms, stop exercising immediately and seek advice from your doctor if necessary.
- + The owner must communicate all warnings and instructions to the user.

### **WARNING**

- + This equipment may not be used by children under the age of 14.
- + Children should not be allowed unsupervised access to the equipment.
- + Persons with disabilities must have a medical license and must be under strict observation when using the equipment.
- + The equipment is strictly for use by one person at a time.
- + If your equipment provides a safety key, the clip of the safety key must be attached to your clothing before starting your training. In the event of a fall, the EMERGENCY STOP of the equipment can be initiated.
- + There is a risk of injury from spinning pedals and/or an exposed flywheel in the absence of a freewheel. Never get on or off the equipment when the pedals or the flywheel are still moving. Always make sure that the pedals and the flywheel have come to a complete stop.
- + Support yourself with at least one hand on the handlebar when getting on and off the equipment. Only dismount from the equipment when the pedals have come to a complete stop.
- + Keep your hands, feet and other body parts, hair, clothing, jewellery and other objects well clear of moving parts.
- + During use, wear suitable sports clothing rather than loose or baggy clothing. When wearing sports shoes, make sure they have suitable soles, preferably made of rubber or other non-slip materials. Shoes with heels, leather soles, studs or spikes are unsuitable. Never exercise barefoot.

### **CAUTION**

- + If your equipment needs to be connected to the power supply with a mains cable, make sure that the cable is not a potential tripping hazard.
- + Make sure that nobody is within the range of motion of the equipment during training so as not to endanger you or other persons.
- + Always tighten the pedal strap before you start training to prevent your feet from slipping.

 **CAUTION**

- + Be aware that if adjustment devices are left protruding, they may impede the user's movement.

 **ATTENTION**

- + Do not insert any objects of any kind into the openings of the device.
- + To protect the equipment from use by unauthorised third parties, always remove the power cable when not in use and store it in a safe place that is inaccessible to unauthorised persons (e.g. children).
- + Class B and C crank training equipment is not suitable for high accuracy purposes.

## 1.3 Electrical Safety

 **DANGER**

- + In order to reduce the risk of an electric shock, always unplug the equipment from the mains socket immediately after your workout, before assembly or dismantling, and before maintenance or cleaning. Do not pull on the cable.

 **WARNING**

- + Do not leave the equipment unattended while the mains cable is plugged into the mains socket. During your absence, the mains cable must be removed from the mains socket to prevent improper use by third parties or children.
- + If the mains cable or plug is damaged or defective, contact your contract partner. Until repair, the equipment must not be used.

 **ATTENTION**

- + The equipment requires a mains connection of 220-230 V with 50 Hz mains voltage.
- + The equipment may only be connected directly to an earthed socket using the supplied mains cable. Extension cables must conform to VDE guidelines. Always completely unwind the mains cable.
- + The socket must be protected by a fuse with a minimum fuse rating of "16 A, slow blow".
- + Do not make any changes to the mains cable or the mains plug.
- + Keep the mains cable away from water, heat, oil and sharp edges. Do not route the mains cable underneath the equipment or under a carpet or rug, and do not place any objects on top of it.
- + If your purchased item is equipped with a TFT console, software updates must be carried out regularly. Follow the instructions on the console to perform the update(s).
- + The software systems on gym equipment with TFT consoles are set up only for the pre-installed apps. Do not install any additional apps.

 **NOTICE**

- + The pre-installed apps on TFT consoles are produced and provided by external manufacturers. Fitshop does not take any responsibility for the availability, functionality or contents of these apps.

## 1.4 Set-Up Place

### **WARNING**

- + Do not place the equipment in main corridors or escape routes.

### **CAUTION**

- + Choose a location in which to place the equipment such that there is enough free space/clearance to the front, the rear and to the sides of the equipment.
- + The training room should be well ventilated during training and not be exposed to any draughts.
- + Choose the place in which to set up the equipment such that there is enough free space/clearance to the front, the rear and to the sides of the equipment.
- + The free area in the direction from which the exercise equipment is accessed must be at least 0.6 m larger than the exercise area.
- + The set-up and mounting surface of the equipment should be flat, loadable and solid.

### **ATTENTION**

- + The device may only be used in one building, in sufficiently tempered and dry rooms (ambient temperatures between 10°C and 35°C). The equipment should not be used outdoors or in rooms with high humidity (over 70%) like swimming pools.
- + A floor protective mat/equipment underlay can help to protect high-quality floor coverings (parquet, laminate, cork, carpets) from dents and sweat and can help to level out slight unevenness.
- + For Class S equipment, the exercise equipment may only be used in areas where access, supervision and control are specifically regulated by the owner.

### 2.1 General Instructions



#### **DANGER**

- + Do not leave any tools, packaging materials such as foils or small parts lying around, as otherwise there is a danger of suffocation for children. Keep children away from the equipment during assembly.



#### **WARNING**

- + Pay attention to the instructions attached to the equipment in order to reduce the risk of injuries.



#### **CAUTION**

- + Ensure to have sufficient room for movement in each direction during assembly.
- + The assembly of the equipment must be carried out by at least two adults. If in doubt, seek the help of a third technically skilled person.



#### **ATTENTION**

- + To prevent damage to the equipment and the floor, assemble the equipment on a mat or packaging board.



#### **NOTICE**

- + In order to make the assembly as simple as possible, some screws and nuts to be used can already be pre-assembled.
- + Ideally, assemble the equipment at its later set-up place.

## 2.2 Scope of Delivery

The scope of delivery consist of the following parts. At the beginning, check whether all parts and tools belonging to the device are included in the scope of delivery and whether damage has occurred. In the event of complaints, the contractual partner must be contacted directly.

**⚠ CAUTION**

If parts of the scope of delivery are missing or damaged, the assembly must not be carried out.

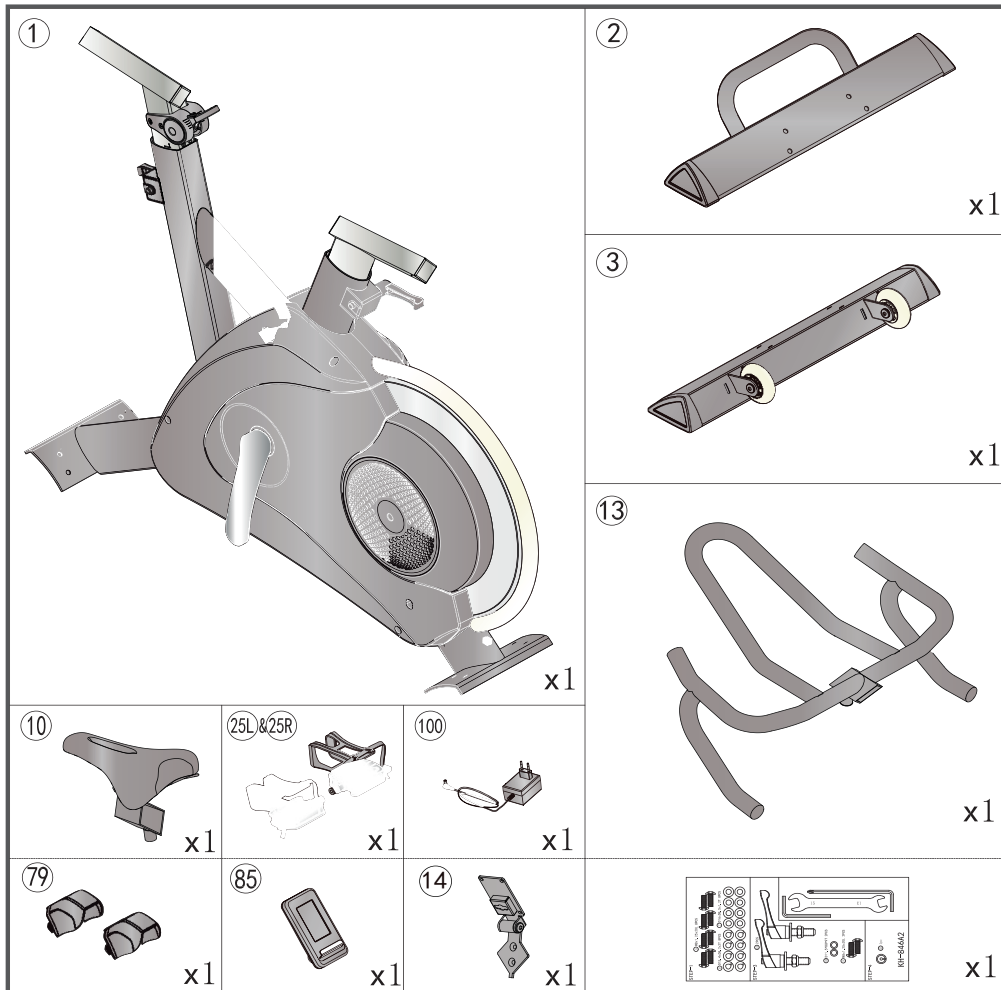

No.	Description	No.	Description
1	Main frame	25R	Right pedal
2	Front stabiliser	25L	Left pedal
3	Rear stabiliser	79	Covers
10	Saddle	85	Console
13	Handlebars	100	Power cable
14	Computer fixing plate		Screws and tools

## 2.3 Assembly

Before assembly, take a close look at the individual assembly steps shown and carry out the assembly in the order given.

### ① NOTICE

- + First loosely screw all parts together and check that they fit properly. Tighten the screws using the tool only when you are instructed to do so.
- + If you have difficulty recognising the graphics, we recommend that you open and/or download the PDF instructions stored in the webshop on your end device (e.g. smartphone, tablet or PC). There you have the option of zooming in closer. Please note that the Adobe Acrobat Reader programme must be installed on your end device in order to open the file.

### Step 1: Assembly of the Front and Rear Stabilisers

1. Mount the front stabiliser (2) and the rear stabiliser (3) onto the main frame (1) with washers (7), spring washers (6) and allen screws (5).
2. Mount the covers of the transport wheels (79).

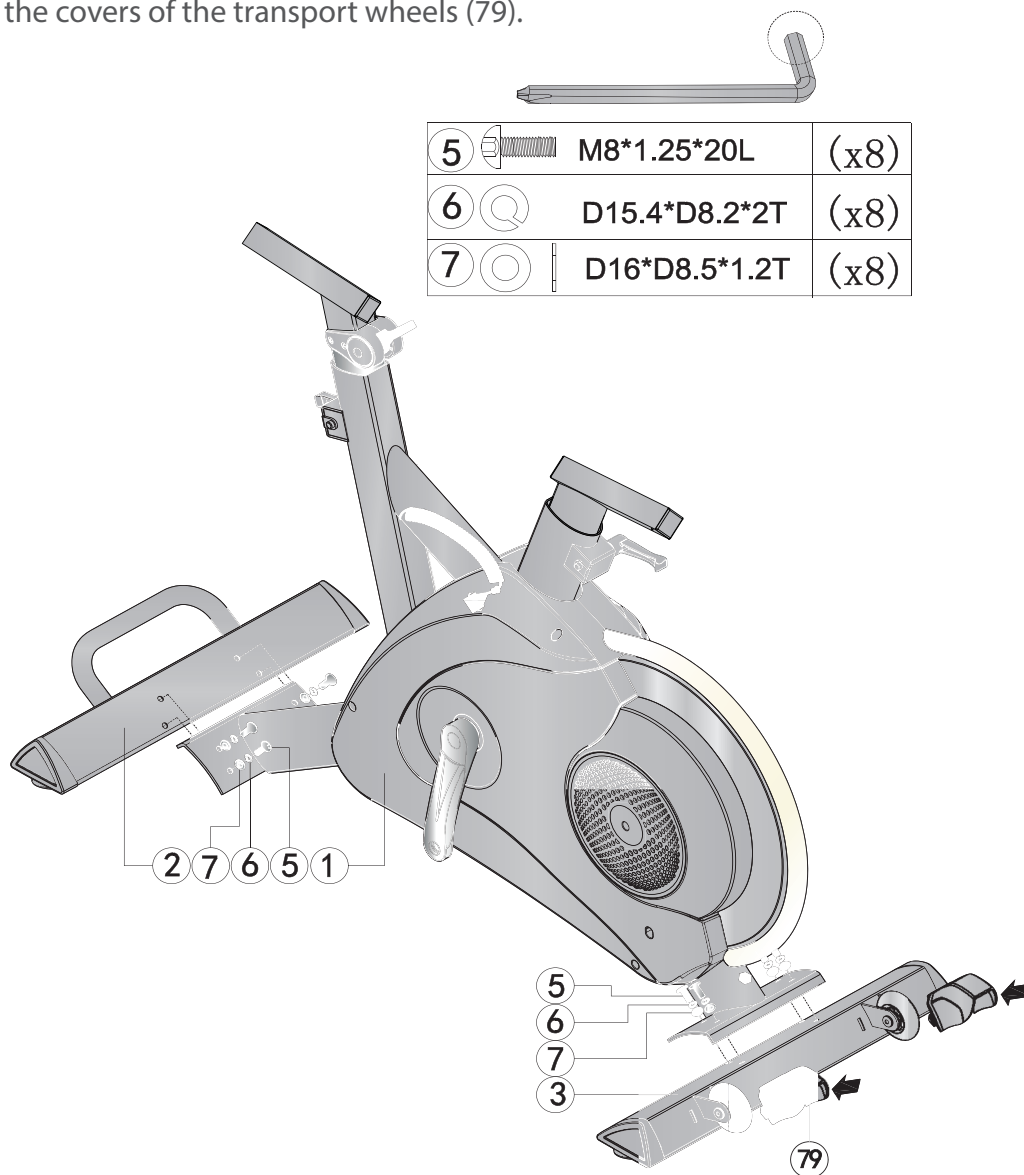

## Step 2: Assembly of the Handlebar and Saddle

1. Fasten the handlebar (13) onto the handlebar support (8) with an adjusting screw (12).
2. Fasten the saddle (10) onto the saddle support (9) with an adjusting screw (12) and tighten with a fastening bolt (97).

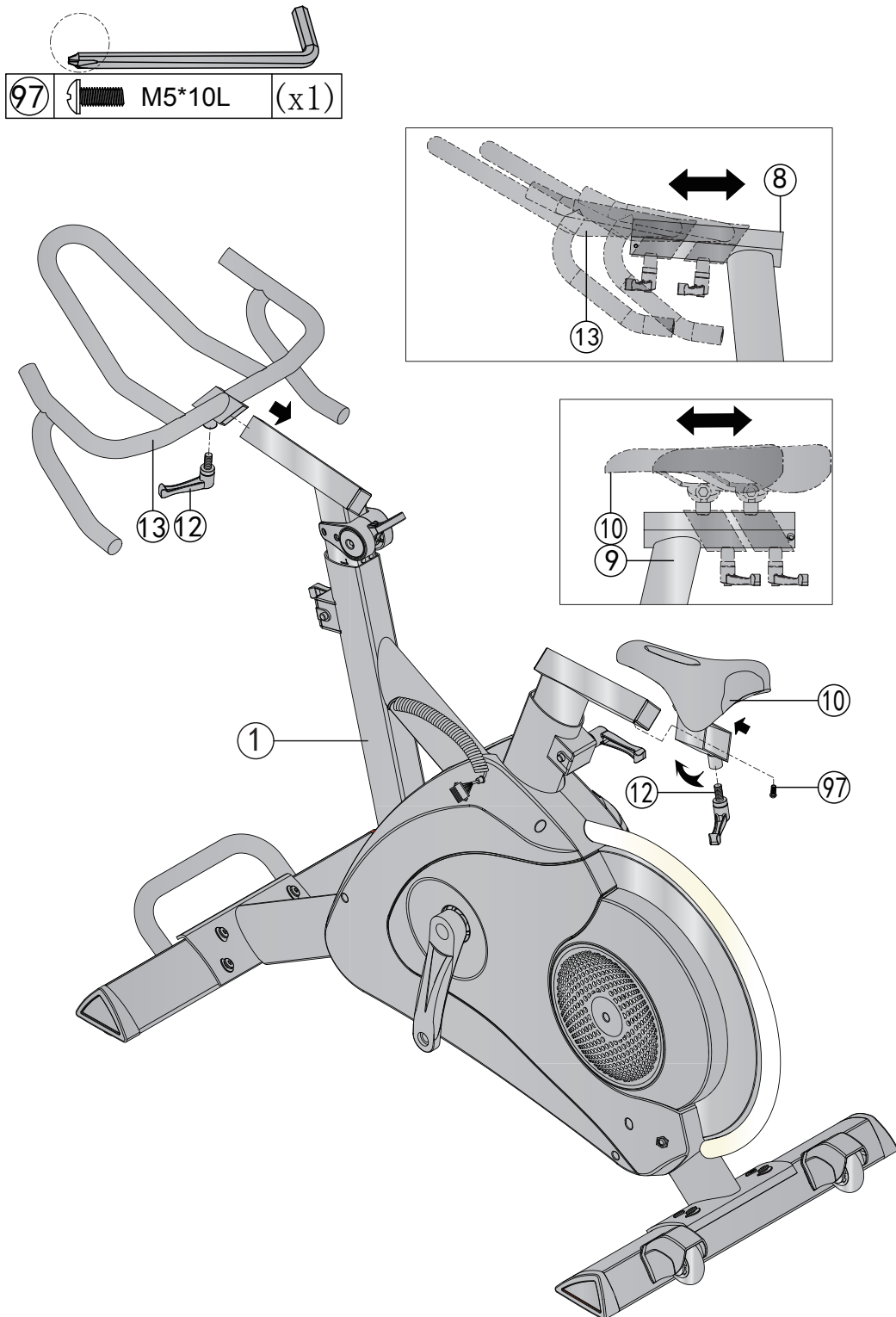

### Step 3: Assembly of the Console

1. Mount the computer fixing plate (14) to the handlebars (13) with two screws (86) (Fig. a)
2. Pull the computer cable (105) through the hole of the fixing plate (14) (Fig. b).
3. Place the cable plug (83) onto the computer cable (105) and push into place (Fig. c).
4. Connect the computer cable (105) to the computer (85). Mount the computer (85) onto the fixing plate (14) with four screws (84) (Fig. d).

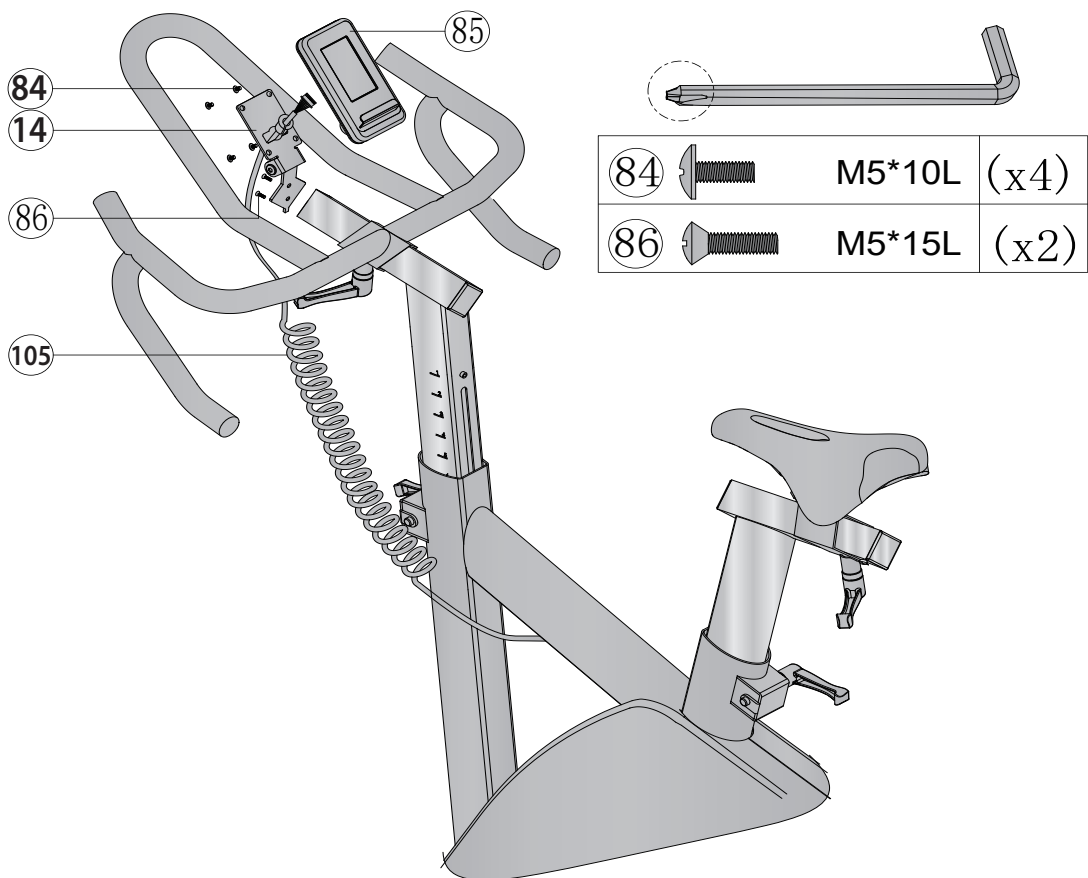
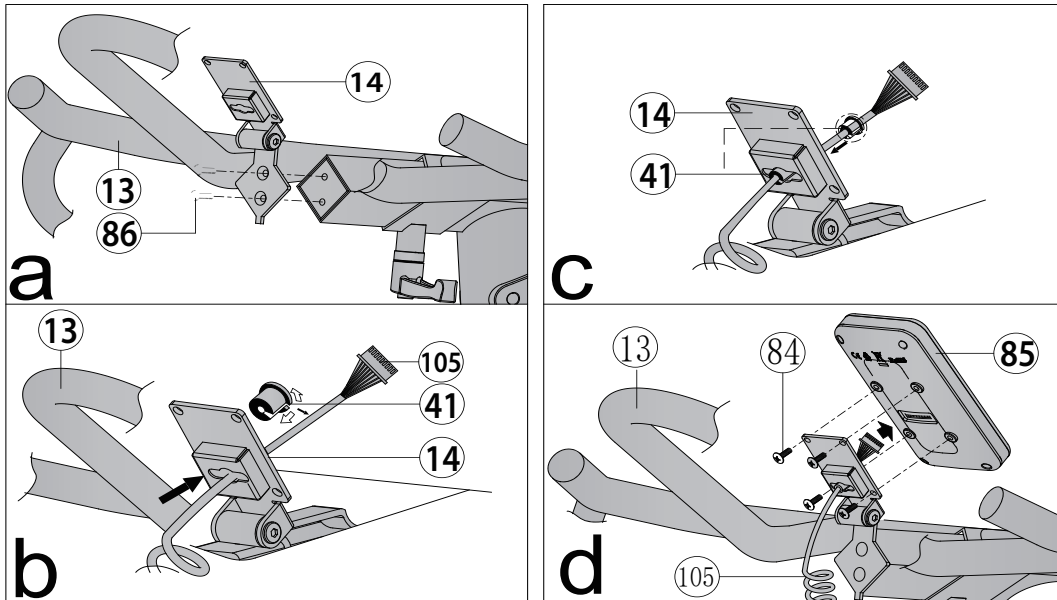



#### Step 4: Assembly of the Pedals

Screw the left pedal (25L) anti-clockwise onto the left crank. Screw the right pedal (25R) clockwise onto the right crank.



#### CAUTION

Make sure to screw in the pedals completely.

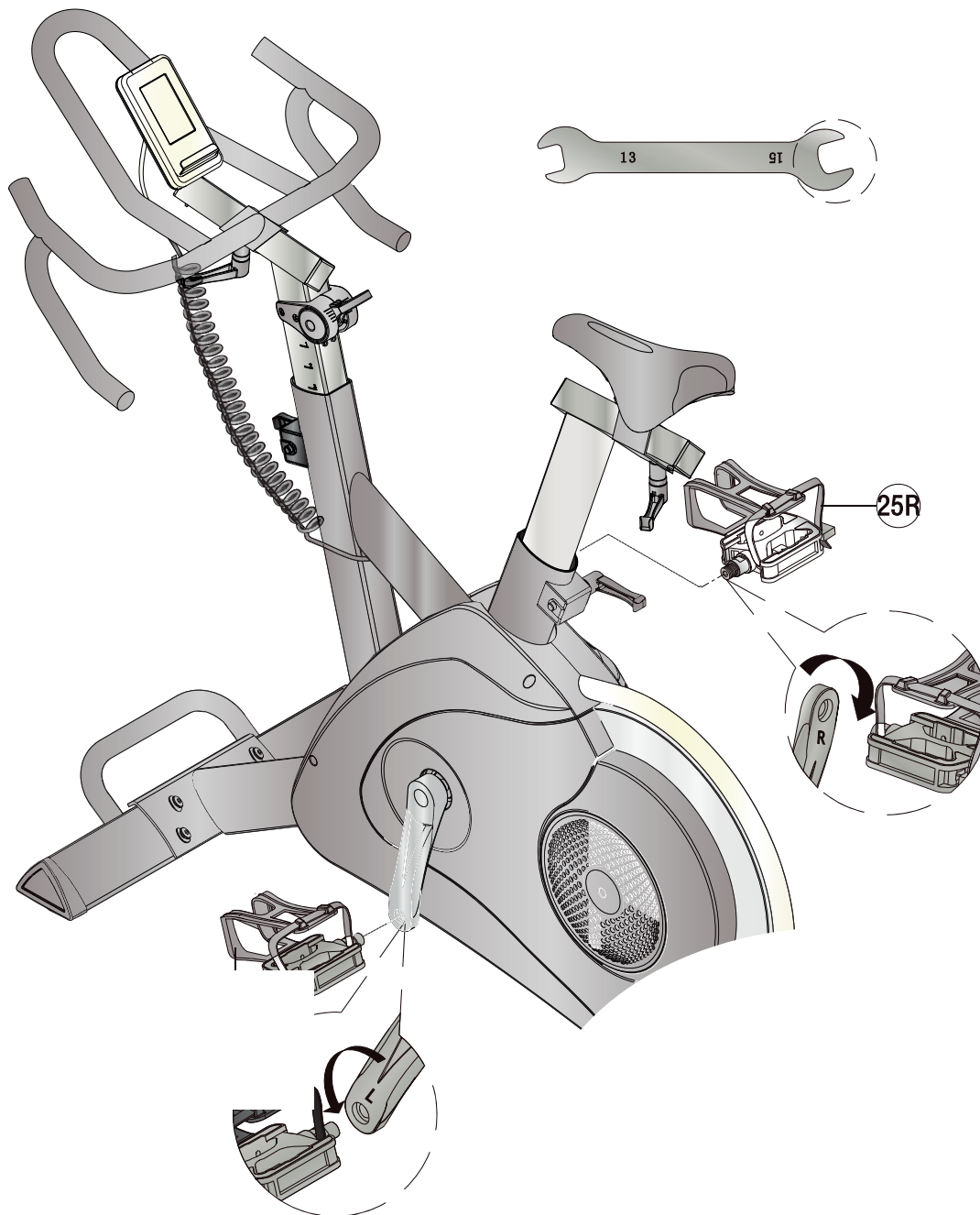

### Step 5: Alignment of the Feet

If the floor is uneven, you can stabilize the equipment by turning the two setting screws under the main frame.

1. Lift the equipment on the desired side and rotate the setting screws under the main frame.
2. Rotate the screws clockwise in order to remove them and to raise the equipment.
3. Rotate them counterclockwise in order to lower the equipment.

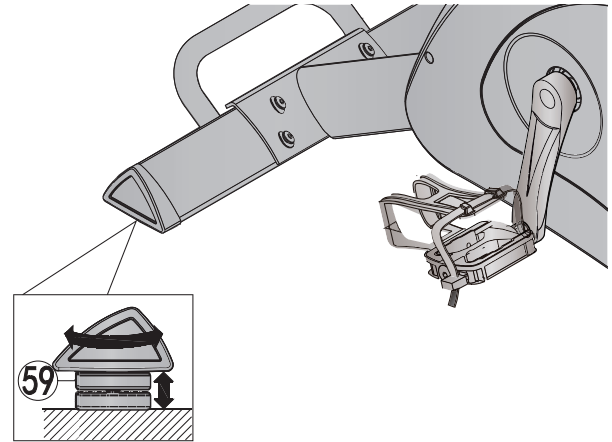

### Step 6: Connecting the Equipment to the Mains Supply

#### ► ATTENTION

The equipment must not be connected to a multiple socket, otherwise it cannot be guaranteed that the equipment will be supplied with sufficient power. Technical errors can result.

Plug the power plug (100) into a wall outlet that complies with the instructions in the chapter on electrical safety.



## **Correctly Getting On and Off**

1. To get on, grip the handles with both hands and first step onto the left pedal with your left foot or onto the right pedal with your right foot and then place your foot onto the other pedal.
2. To get off, grip the handles with both hands and place one foot next to the equipment and then the other foot.

## 2.4 Equipment settings

### 2.4.1 Emergency brake

 **WARNING**

Use this safety function in every emergency situation in which you need to dismount from the Indoor Cycle or need to stop the flywheel.

The emergency brake (34) mounted towards the front of the main frame and is designed to bring the flywheel to a standstill.

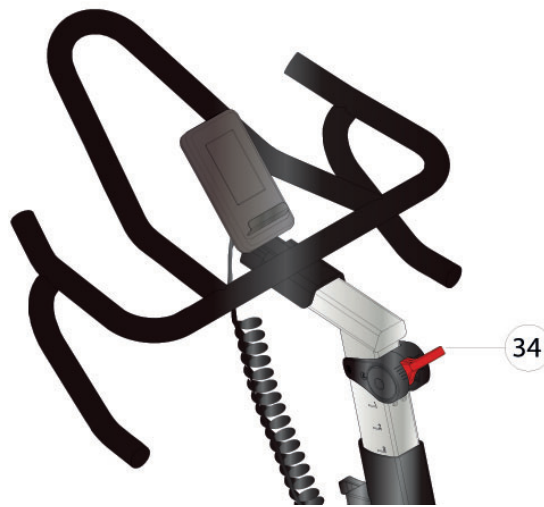

## 2.4.2 Saddle

### Vertical Adjustment

1. Stand next to the saddle support (9) and loosen the adjustable screw (12).
2. Move the saddle to the height of your hip and re-tighten the adjustable screw (12) at this position.



#### CAUTION

Do not adjust over the STOP- mark.

3. Turn the pedals in a vertical position (6 & 12 o'clock).
4. Place a foot on the lower pedal and get on the Indoor Cycle.

*Your knee should be in a slightly bent position.*

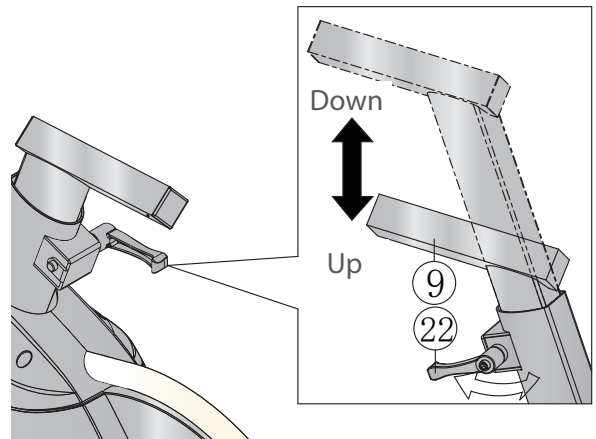

#### NOTICE

- + When your leg is too straight or your foot doesn't reach the pedal, the saddle must be lowered.
  - + When your leg is bent too much, the saddle must be raised.
5. To further adjust the saddle, dismount the Indoor Cycle first.
  6. When you have finished adjusting the saddle, tighten the adjustable screw (12) to fix the saddle support (9).

### Horizontal Adjustment

1. Get on the Indoor Cycle and turn the pedals in a horizontal position (6 & 12 o'clock).

*Your front knee should now be slightly in front of the axle of the pedals.*

#### NOTICE

- + When your knee is too far forwards, the saddle must be re-positioned backwards.
  - + When your knee is behind or over the axle, the saddle must be re-positioned forwards.
2. To adjust the saddle (10) horizontally, dismount from the Indoor Cycle and loosen the adjustable screw (12) on the saddle.
  3. Move the saddle (10) forwards or backwards and re-tighten the adjustable screw (12) at the position.



#### CAUTION

Do not adjust over the STOP- mark.

4. To further adjust the saddle, dismount from the Indoor Cycle first.
5. When you have finished adjusting the saddle, tighten the adjustable screw (12) to fix the saddle (10).

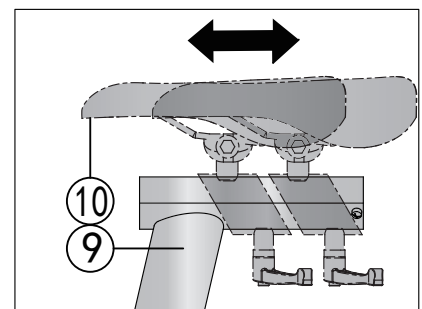

## 2.4.3 Handlebars

### Vertical Adjustment

1. Loosen the adjustable screw on the handlebar support (8) and adjust the height of the handlebars to the height of the saddle (10).
2. Re-tighten the adjustable screw on the handlebar support (8) at this position.



#### CAUTION

Do not adjust over the STOP- mark.



#### NOTICE

- + A higher setting results in a more upright position.
- + A lower setting results in a bent over (racer) position.

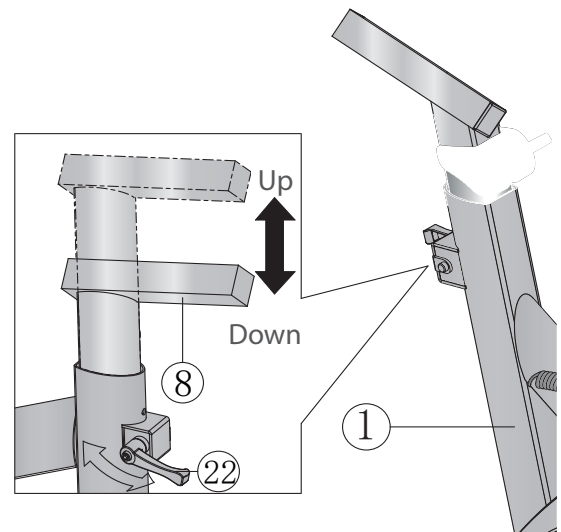

### Horizontal Adjustment

1. Loosen the adjustable screw underneath the handlebars (13) and move the handlebars forwards or backwards.
2. Re-tighten the adjustable screw at the desired position.



#### CAUTION

Do not adjust over the STOP- mark.

*You should be able to hold onto the handlebars with elbows slightly bent.*

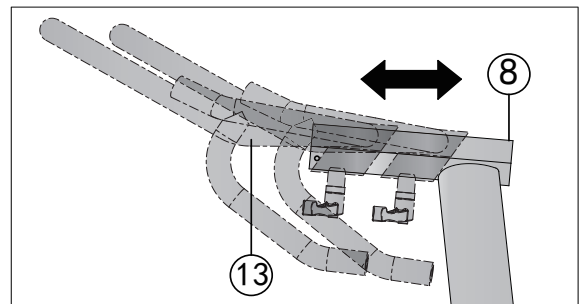

3. When you have finished adjusting the handlebars, tighten the adjustable screw underneath the handlebars to fix the handlebars (13).



## 3 OPERATING INSTRUCTIONS

### ① NOTICE

- + Familiarise yourself with all the functions and setting options of the device before starting training. Have the proper use of this product explained to you by a specialist.
- + Always start your training with low intensity and increase evenly and gently. End your training with a cool-down phase. If you are unsure, please consult your physician.

### 3.1 Console Display



<b>TIME (Zeit)</b>	<ul style="list-style-type: none"> <li>+ Display of the elapsed training time</li> <li>+ Setting range: 0:00 - 99:00</li> <li>+ Display range: 0:00 - 99:59</li> </ul>
<b>SPEED</b>	<ul style="list-style-type: none"> <li>+ Display of the current speed in km/h</li> <li>+ Display range: 0.0 - 99.9</li> </ul>
<b>DISTANCE</b>	<ul style="list-style-type: none"> <li>+ Display of the distance in km</li> <li>+ Setting range: 0.00 - 99.0</li> <li>+ Display range: 0.00 - 99.99</li> </ul>
<b>CALORIES</b>	<ul style="list-style-type: none"> <li>+ Display of calories burned in kcal</li> <li>+ Setting range: 0 - 9990</li> <li>+ Display range: 0 - 9999</li> </ul>
<b>PULSE</b>	<p> <b>WARNING</b> This Indoor Cycle is not medical equipment. The heart rate measurement of the Indoor Cycle can be unprecise. Different factors can influence the heart rate reading. The heart rate readings are only meant as a guide for training.</p> <p> <b>NOTICE</b> Measuring your heart rate is only possible with an optionally available chest strap monitor.</p> <ul style="list-style-type: none"> <li>+ Display of your heart rate</li> <li>+ Setting range: 30 - 230</li> <li>+ Display range: 0 - 230</li> </ul>
<b>RPM (revolutions per minute)</b>	<ul style="list-style-type: none"> <li>+ Display of the current revolutions per minute (RPM)</li> <li>+ Display range: 0-999</li> </ul>
<b>WATT</b>	<ul style="list-style-type: none"> <li>+ Setting range: 0 - 350</li> </ul>

### 3.2 Button functions

<b>RECOVERY</b>	A test of the rate of recovery.
<b>RESET</b>	Press and hold the button for 2 seconds to re-start the console. To go back to the main menu when making settings.
<b>DOWN</b>	To choose from programs and setting values.
<b>UP</b>	To choose from programs and setting values.
<b>START/STOP</b>	Start and stop your training
<b>MODE</b>	Confirming an entry.



### 3.3 Turning on and setting up the Indoor Cycle

After turning on the bike or holding the REST button for 2 seconds, a signal will sound for 1 second and all values will be displayed on the LCD screen (see fig. 1). Afterwards the display shows the settings for the wheel diameter and the speed measurement unit (see fig. 2) and changes on to the main menu (see fig. 3).

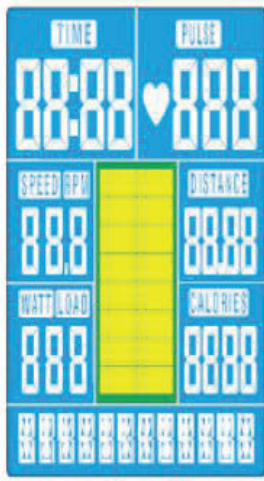

Fig. 1



Fig. 2

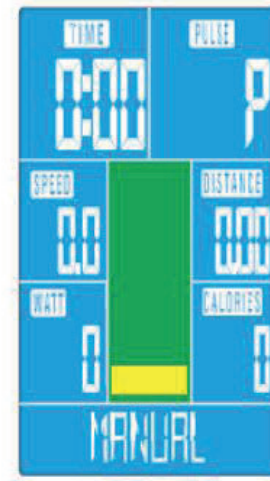

Fig. 3

### 3.4 Programs

There are a total of 19 programs available to choose from:

- + Quick start programs: 1
- + Target programs: 1
- + Pre-set programs: 12
- + Heart rate programs: 4
- + Watt controlled programs: 1

To choose a desired program, while in the main menu press the UP or DOWN-button to scroll through Manual → Beginner → Advance → Sporty → Cardio → Watt and confirm your choice with the MODE button.

#### 3.4.1 Quick Start program

1. To start the quick start program while in the main menu press the START/STOP-button.

*Various values will start counting upwards.*

2. To pause the program, press the START/STOP button again.
3. To end the program, press the RESET button.

*The display will change to the main menu.*

### 3.4.2 Target program (Manual)

 **WARNING**

This Indoor Cycle is not medical equipment. The heart rate measurement of the Indoor Cycle can be unprecise. Different factors can influence the heart rate reading. The heart rate readings are only meant as a guide for training.

For target programs values for time, distance, calories or heart rate can be set.

 **NOTICE**

Measuring your heart rate is only possible with an optionally available chest strap monitor.

1. Choose the target program (Manual) and confirm your choice with the MODE button.
2. Choose the value that should be set with the UP/DOWN buttons and confirm your choice with the MODE button.
3. To raise or lower the value, use the UP/DOWN buttons and confirm the setting with the MODE button.
4. To start the program, press the START/STOP button.

*The target values count down and the other values count upwards.*

5. To pause the program, press the START/STOP button again.
6. To end the program, press the RESET button.

*The display will change to the main menu.*

### 3.4.3 Pre-set programs - Beginner

1. Choose the program (Beginner) and confirm the choice with the MODE button (see fig. 4).

*You can now choose from Beginner 1 - 4 (see fig. 5 and fig. 6).*

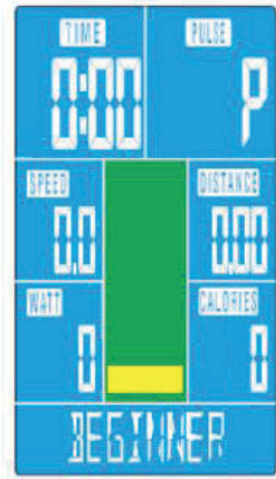

Fig. 4

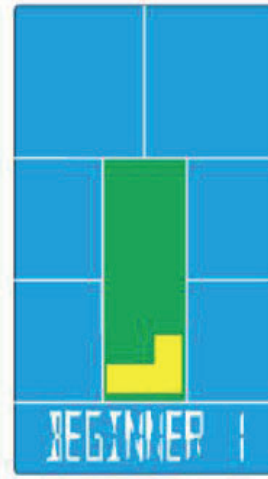

Fig. 5

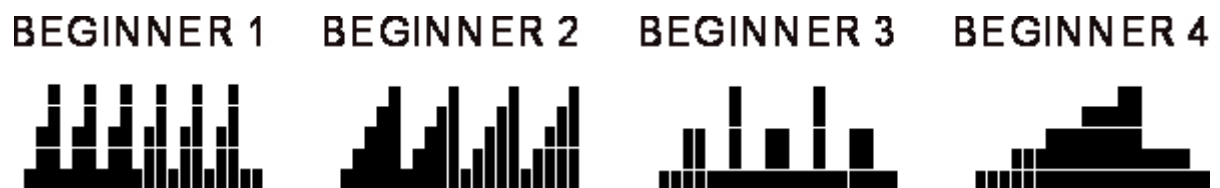

Fig. 6

2. Select a program from Beginner 1 - 4 and confirm your choice with the MODE button.
3. Set the time with the UP/DOWN button and confirm the setting with the MODE button.
4. To start the program, press the START/STOP button.

**① NOTICE**

During Training you can change the resistance with the UP/DOWN buttons..

5. To pause the program, press the START/STOP button again.
6. To end the program, press the RESET button.

*The display will change to the main menu.*

### 3.4.4 Pre-set programs - Advance

1. Choose the program (Advance) and confirm the choice with the MODE button (see fig. 7).

*You can now choose from Advance 1 - 4 (see fig. 8 and fig. 9).*

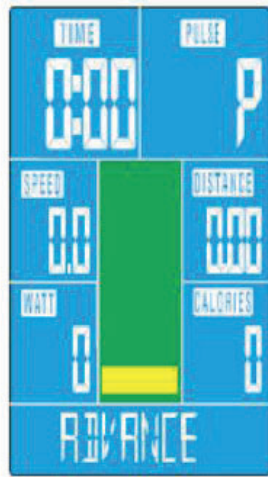

Fig. 7

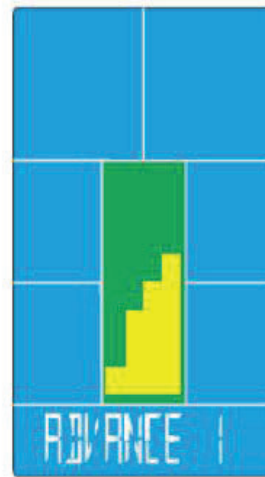

Fig. 8

**ADVANCE 1**



**ADVANCE 2**



**ADVANCE 3**



**ADVANCE 4**



Fig. 9

2. Select a program from Advance 1 - 4 and confirm your choice with the MODE button.
3. Set the time with the UP/DOWN button and confirm the setting with the MODE button.
4. To start the program, press the START/STOP button.

**① NOTICE**

During Training you can change the resistance with the UP/DOWN buttons..

5. To pause the program, press the START/STOP button again.
6. To end the program, press the RESET button.

*The display will change to the main menu.*

### 3.4.5 Pre-set programs - Sporty

1. Choose the program (Sporty) and confirm the choice with the MODE button (see fig. 10).

*You can now choose from Sporty 1 - 4 (see fig. 11 and fig. 12).*

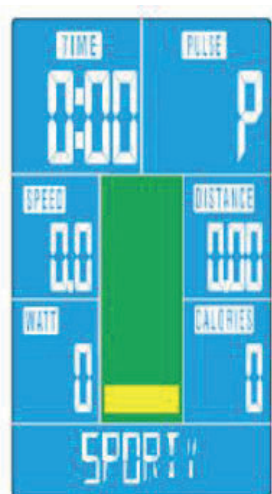

Fig. 10

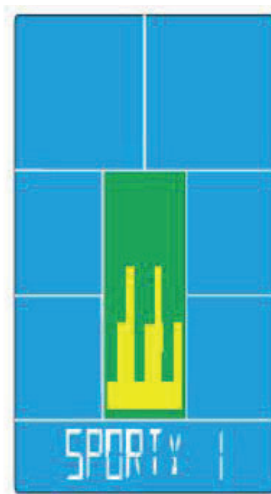

Fig. 11



Fig. 12

2. Select a program from Sporty 1 - 4 and confirm your choice with the MODE button.
3. Set the time with the UP/DOWN button and confirm the setting with the MODE button.
4. To start the program, press the START/STOP button.

**① NOTICE**

During Training you can change the resistance with the UP/DOWN buttons..

5. To pause the program, press the START/STOP button again.
6. To end the program, press the RESET button.

*The display will change to the main menu.*

### 3.4.6 Heart rate controlled programs

#### **⚠ WARNING**

Your training equipment is not a medical device. The heart rate measurement of this equipment may be inaccurate. Various factors can affect the accuracy of the heart rate measurement. The heart rate measurement serves only as a training aid.

#### **📌 NOTICE**

Measuring your heart rate is only possible with an optionally available chest strap monitor.

There are four heart rate programs available to choose from. You can choose from one of the three pre-set target heart rate programs (55%, 75% or 90% of your maximum heart rate) or choose TAG (target) and manually set a target heart rate value. Your maximum heart rate is calculated by the console and is dependant on your age set.

1. Choose the program (Cardio) and confirm the choice with the MODE button (see fig. 13).

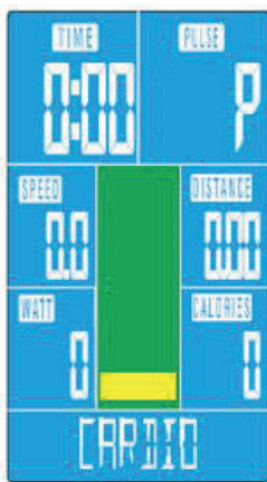

Fig. 13

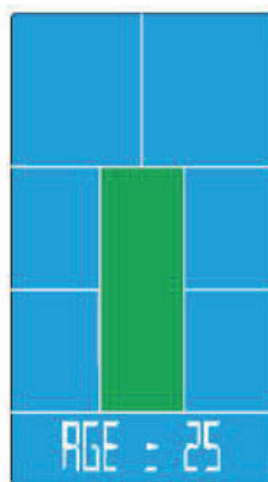

Fig. 14

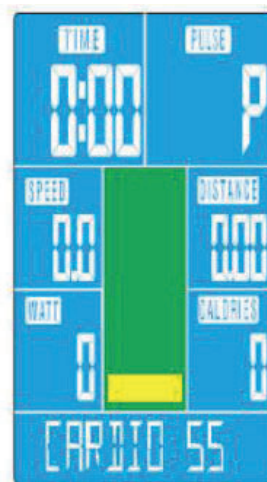

Fig. 15

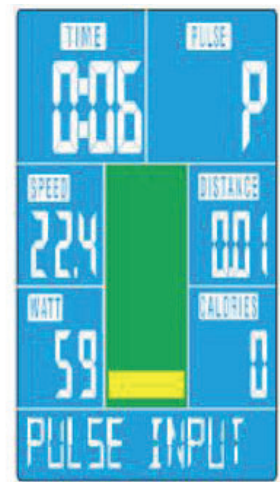

Fig. 16

2. Set your age with the UP/DOWN buttons and confirm the setting with the MODE button (see fig. 14)
3. Select the desired heart rate program (55%, 75%, 90% or TAG) with the UP/DOWN buttons and confirm with the MODE button (see fig. 15).
- 3.1. If you choose the target heart rate program (TAG), set the target heart rate with the UP/DOWN button and confirm the setting the MODE button.
4. Set the time with the UP/DOWN button and confirm the setting with the MODE-button.
5. To start the program, press the START/STOP button.

#### **📌 NOTICE**

- + Should no heart rate be recognised after 6 seconds, the display will show "PULSE INPUT" (see fig. 16).
- + During Training you can change the resistance with the UP/DOWN buttons.

6. To pause the program, press the START/STOP button again.
7. To end the program, press the RESET button.

*The display will change to the main menu.*

### 3.4.7 Watt controlled programs

1. Choose the program (Watt) and confirm the choice with the MODE button (see fig. 17).

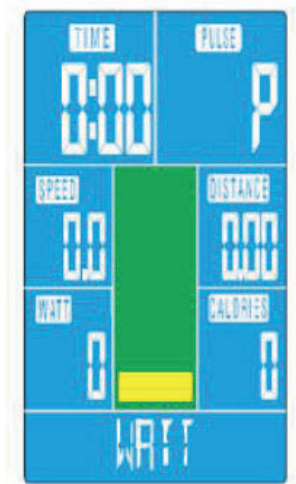

Fig. 17



Fig. 18



Fig. 19

2. Set the Watt value (10 - 350) with the UP/DOWN buttons and confirm the setting with the MODE button (see fig. 18).
3. Set the time with the UP/DOWN buttons and confirm the setting with the MODE button.
4. To start the program, press the START/STOP button.

**① NOTICE**

The console automatically changes the resistance in accordance with the set Watt value.

5. To pause the program, press the START/STOP button again.
6. To end the program, press the RESET button.

*The display will change to the main menu.*

### 3.4.8 Recovery program

The recovery program measures your recovery rate after a training session.

**① NOTICE**

Measuring your heart rate is only possible with an optionally available chest strap monitor.

1. After a training session press the RECOVERY button. Make sure that your chest strap monitor is connected.

*The display shows a countdown that runs from 00:60 down to 00:00 (see fig. 20).*

*When the measuring has finished, the display will show a value between F1 (very good) up to F6 (very bad) (see fig. 21).*

2. To end the program, press the RECOVERY button again.



Fig. 20

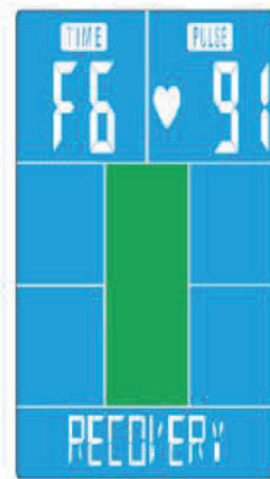

Fig. 21



### 3.5 Wireless Connection and Fitness Apps

This console is equipped with a wireless interface. Please take note that your mobile device needs to be compatible with the wireless interface of the treadmill.

To use training apps you will have to activate the wireless connection function on your mobile device (tablet or smart phone) and start the fitness app. Select your fitness equipment. Please follow the instructions given in the app. You will find the name of your fitness equipment on a small sticker on the back of the console.

You will find the fitness apps in the app stores of Google or Apple. There you will find the apps "Kinomap" or "Zwift". Please note that these apps are produced by an external manufacturer. Fitshop does not take any responsibility regarding the availability, functionality or contents of these programmes.

#### IMPORTANT NOTE

The pre-installed apps are produced and provided by external manufacturers. Changes and availability within these apps might occur. Fitshop does not take any responsibility and can not be held liable for the availability, functionality or contents of these apps. To make sure the pre-installed apps are working correctly, they must be updated regularly. If needed, the respective app will notify you to do so. To update the app, you need a google account. A google email is sufficient. Just follow the instructions on the screen to perform the update.

Please note: The system is set up only for the pre-installed apps. Do not install any additional apps as their proper functionality can not be guaranteed. The installation of other apps might cause technical issues.

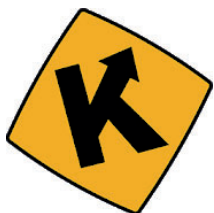
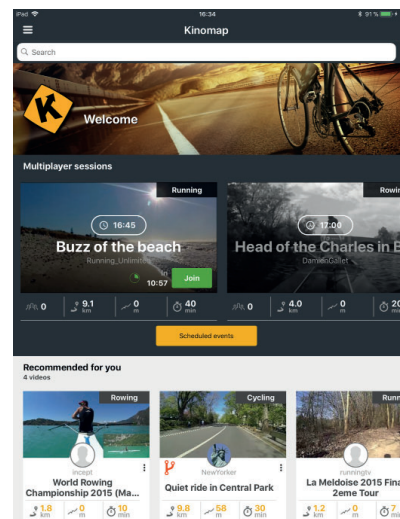
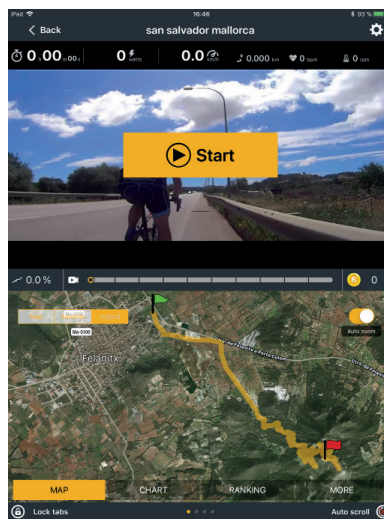
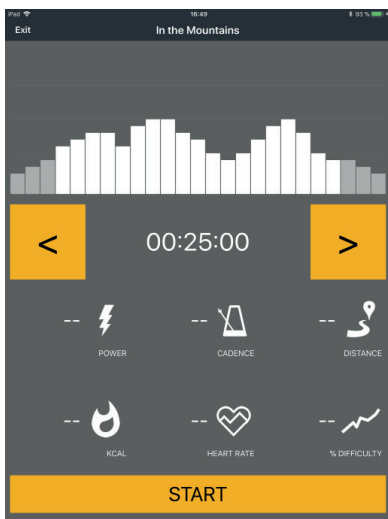

Example: Kinomap

## 4.1 General Instructions

### WARNING

- + The storage location should be chosen so that improper use by third parties or children can be prevented.
- + If your equipment does not have transportation wheels, the equipment must be disassembled before transportation.

### ▶ ATTENTION

- + Make sure that the equipment is protected from moisture, dust and dirt in the selected storage location. The storage location should be dry and well ventilated and have a constant ambient temperature between 10°C and 35°C.

## 4.2 Transportation Wheels

### ▶ ATTENTION

If you want to transport your equipment over particularly sensitive and soft floor coverings, such as parquet, planks or laminate, lay out the transport route with cardboard or similar to avoid possible floor damage.

1. Stand behind the equipment and lift it until the weight is transferred to the transportation wheels. After that, you easily can move the equipment to a new position. For long transport distances the equipment should be disassembled and safely packed.
2. Select the new location by following the instructions in the section 1.4 of this manual.

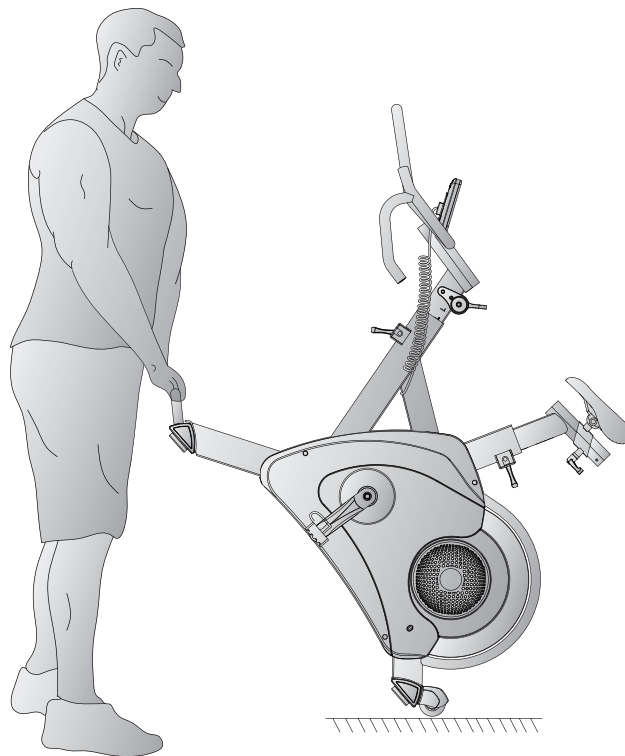

## 5.1 General Instructions



### WARNING

- + Do not make any improper changes to the equipment.



### CAUTION

- + Damaged or worn components may affect your safety and the life of the equipment. Therefore, immediately replace damaged or worn components. In such a case, contact the contract partner. The equipment must not be used until it has been repaired. If necessary, use only original spare parts.

### ▶ ATTENTION

- + In addition to the instructions and recommendations for maintenance and care given here, additional service and/or repair work may be necessary; this must only be carried out by authorised service technicians.

## 5.2 Faults and Fault Diagnosis

The equipment undergoes regular quality controls during production. Nevertheless, faults or malfunctions may occur. Frequently, individual parts are responsible for these disturbances, an exchange is usually sufficient. Please refer to the following overview for the most common errors and how to correct them. If the equipment still does not function properly, contact your contract partner.

Fault	Cause	Solution
Cracking in the pedal area	Pedals loose	Tighten the pedals
Equipment wobbles	Equipment is not level	Align the feet
Handlebar/saddle wobbles	Loose screws	Tighten screws firmly
Display is blank/is not working	Batteries empty or loose cable connection	Replace batteries or check cable connections

No pulse display	<ul style="list-style-type: none"> <li>+ Sources of interference in the room</li> <li>+ unsuitable chest strap</li> <li>+ Wrong position of chest strap</li> <li>+ Chest strap defective or battery empty</li> <li>+ Pulse display defective</li> </ul>	<ul style="list-style-type: none"> <li>+ Eliminate sources of interference (e.g. mobile phone, WLAN, lawn mower and vacuum cleaner robot, etc. ...)</li> <li>+ Use a suitable chest strap (see "RECOMMENDED ACCESSORIES").</li> <li>+ Reposition chest strap and/or moisten electrodes</li> <li>+ Changing batteries</li> <li>+ Check if pulse display by hand pulse possible</li> </ul>
------------------	---	--

### 5.3 Error Codes and Troubleshooting

The electronics of the equipment continuously carries out tests. In case of deviations, an error code appears on the display and normal operation is stopped for your safety.

**Please contact the contract partner for technical support.**

## 5.4 Maintenance and Inspection Calendar

To avoid damage from body sweat, the equipment must be cleaned with a damp towel (no solvents!) after each training session.

The following routine tasks must be performed at the specified intervals:

Part	Weekly	Monthly
Display console	C	I
Plastic covers	C	I
Screws and cable connections		I
Check pedals for tightness		I
Legend: C = clean; I = inspect		

## 6 DISPOSAL

At the end of its operational life, this equipment cannot be disposed of in normal household waste. Instead, it must be disposed of via an electricals recycling centre. Further information can be obtained from your local authority's recycling service.



The materials can be recycled as per their symbols. Through the reuse, recycling of materials or other forms of recovery of old equipment, you make an important contribution to the protection of the environment.

## 7 RECOMMENDED ACCESSORIES

To make your training experience even more efficient and pleasant, we recommend that you add suiting accessories to your fitness equipment. For indoor cycles this could for example be a **floor mat**, which makes your fitness equipment stand more securely and also protects the floor from sweat or **silicone spray** to keep moving parts in good shape. For many indoor bikes it is possible to replace the **saddle** or **pedals**, as these are usually the same mounts used on bicycles.

If you have purchased a fitness machine with pulse training and want to train your heart rate, we strongly recommend that you use a compatible **chest strap**, as this ensures optimum transmission of the heart rate.

Our range of accessories offers the highest quality and makes training even better. If you would like to find out more about compatible accessories, please go to the detail page of the product in our webshop (the easiest way is to enter the article number in the search field above) and go to the recommended accessories on this page. Alternatively, you can use the QR-code provided. Of course, you can also contact our customer service: by telephone, e-mail, in one of our branches or via our social media channels. We will be happy to advise you!



floor mat



chest strap



chest strap contact gel



pedals



saddle cover



silicone spray

## 8.1 Serial Number and Model Name

In order to provide you with the best possible service, please have the model name, article number, serial number, exploded drawing and parts list ready. The corresponding contact options can be found in chapter 10 of this operating manual.

**NOTICE**

The serial number of your equipment is unique. It's located on a white sticker. The exact position of this sticker is shown in the following illustration.



Enter the serial number in the appropriate field.

**Serial number:**

**Brand / Category:**

**Model Name:**

**Article Number:**

## 8.2 Parts List

No.	Name	Specification	Qty.
1	Main Frame		1
2	Front Stabilizer		1
3	Rear Stabilizer		1
4L	Left Triangle Cap	95.7*57.2*51.3	2
4R	Right Triangle Cap	95.7*57.2*51.3	2
5	Allen Bolt	M8x1.25x20L	10
6	Spring Washer	D15.4xD8.2x2T	10
7	Flat Washer	D16xD8.5x1.2T	10
8	Front Post		1
9	Seat Post		1
10	Seat	DD2684	1
11	Seat Adjustable Tube		1
12	L Knob		2
13	Handlebar		1
14	Computer Fixing Plate		1
15	pipe close		3
16	Cover Of Front Post	80*55*147	1
17	Inner Insert	80*55*147	1
18	Curved Plate Of Flywheel		1
19	Stop Plate(1)	39*35*17	2
20	Spring	D12.7*D1.3*20.7	2
21	Stop Plate(2)	38*35*17	2
22	L Knob 50L	M10*50L	2
23L	Left Chaincover	729.2*531.9*81.5	1
23R	Right Chaincover	729.2*531.9*77	1
24L	Left Crank	170*9/16"-20BC	1
24R	Right Crank	170*9/16"-20BC	1
25L/R	Pedal	JD-037V/16"	1
26	Bolt	M8x1.0x16	2
27	Bolt Cover	D23x6.5	2
28	Screw	M10*1.5*20L	5



29	Nut	M10*1.5*8T	5
30	Round Cross Bolt	M5x0.8x15L	4
31	Pin	D6*26.5*7.7	1
32	Cross Screw	ST4.2*1.4*20L	9
33L	Left Cover Of Brake	95.4*53*33.4	1
33R	Right Cover Of Brake	95.4*53*31.2	1
34	Brake Handlebar	101.1*48.2*37	1
35	Belt	PJ5,1253L	1
36	Puelly	D285-,PK6	1
37	Bb Sets	127.5L	1
38	Bolt	M8*1.25*95L	1
39	Outer Flywheel	D420*17	1
40	Inner Flywheel	D290*38	1
41	cable plug		2
42	Round Cross Screw	M5*0.8*35L	1
43	Nut	M5*0.8*5T	1
44	Screw	M6*1*15L	8
45	Tension Cable	230L	1
46	Lower Tension Cable	1300L	1
47	Magnet Fixing Bracket		1
48	Magnet	D18*10T	8
49	Magnet Fixing Plate		1
50	Axle Of Magnet Fixing Bracket	D8.2*65L	1
51	Spring	D1.2*55L	1
52	Flat Washer	D18*D8.5*1.0T	1
53	Nylon Nut	M8*1.25*8T	5
54	Buffer	D9*D5.8*13	6
56	Magnet Cell	29*3*3	6
57	Cross Bolt	M5*0.8*10L	3
59	Adjustable Round Wheel	D59*M10*40L	4
60	Bolt	M8*1.25*40L	2
61	Round Moving Wheel	D70.5*23	2
62	Bushing	D22.2*D8.2*7T	4
63	Nylon Nut	M8*1.25*8T	3
64	Screw	ST4*1.41*12L	10

65	Idle Wheel Fixing Plate		1
66	Carriage Bolt	M8*1.25*20L	3
67	Adjustable Bolt	M6*1.0*46	1
68	Nut	M6*1*5T	1
69	Bearing	6203-2RS	2
70	Flat Washer	D25*D8.5*2T	2
71	Flat Washer	D18*D8.5*1.2T	2
72	C Ring	S-17(1T)	2
73	Curved Washer	D17*D22*0.3T	1
74	Nut	M8*1.25*6T	1
75	Screw	M8*1.25*16L	4
76	Spring	D1.4*55L	1
77	Fixing Plate Of Brake Strap	125.2*62*3.0T	1
78	Bolt	M8*52L	1
79	Cover Of Moving Wheel	93.2*64.7*62	2
80	Brake Plate	54.5*37*13	1
81	Cow Leather	52*31*4T	1
82	Bolt	M8x1.25x45L	1
83	Cable Plug	D4*D12*13	2
84	Cross Bolt	M5*0.8*10L	4
85	Computer	SM-2534-64	1
86	Bolt	M5*0.8*15L	2
87	Round Head Screw	M6*1.0*50L	1
88	Screw	M6*1*15L	2
89	Tension Fixing Plate	25*24*3T	1
90	Screw	ST4.2*1.4*15L	4
91	Fixing Plate (1)	105.5*35*2.5T	1
92	Buffer	D10*5.5T	2
93	Bolt	M5*0.8*10L	2
94	Flat Washer	D15*D5.2*1.0T	2
95	Fixing Plate (2)	105.5*10*2.5T	1
96	Round Magnet	M02	1
97	Bolt	M5*0.8*10L	1
98	Sensor Bracket	24*22*2.5T	1
99	Sensor Cable	250L	1

100	Adaptor	9V.1A	1
101	Electric Cable	700L	1
102	Flat Washer	D14*D6.5*0.8T	2
103	Cross Screw	ST4.2x1.4x12L	4
104	Motor		1
105	Upper Computer Cable	300L	1
55	Nylon Nut	M6*1.0**6T	1
58	Permanent seat		1
108	Bolt	M6*1.0*15L	2
	Inner-Hex-Spanner		1
	open-wrench		1
	inner hex wrench		1

# 8.3 Exploded Drawing

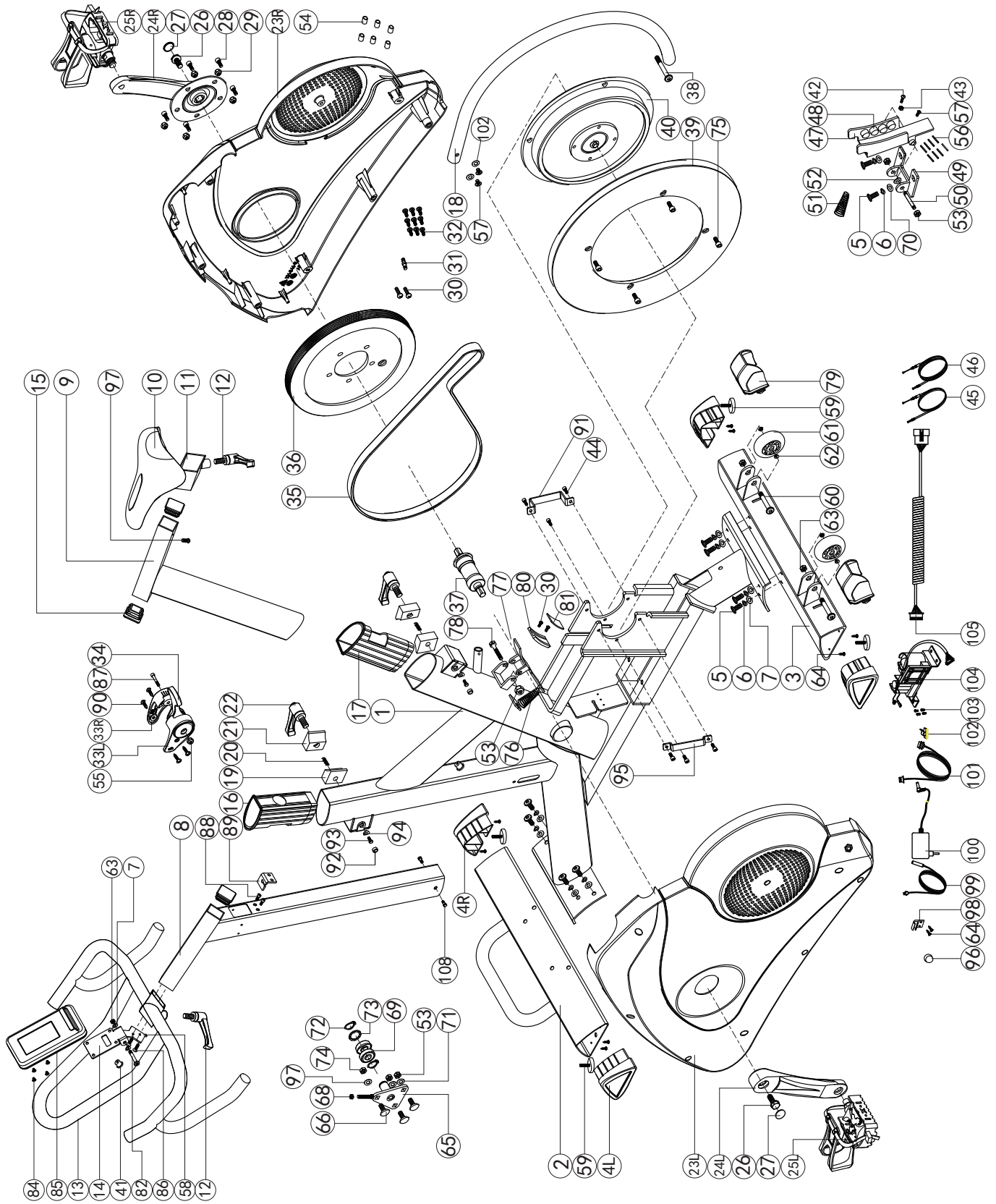

Products from TAURUS® are subject to strict quality control. However, if a fitness equipment purchased from us does not work perfectly, we take it very seriously and ask you to contact our customer service as indicated. We are happy to help you by phone via our service hotline.

### **Error Descriptions**

Your fitness equipment is developed for long-term, high-quality training. However, should a problem arise, please first read the operating instructions. For further assistance, please contact your contract partner or call our service hotline. To ensure your problem is solved as quickly as possible, please describe the defect as exactly as possible.

In addition to the statutory warranty, we provide a warranty for every fitness equipment purchased from us according to the following provisions.

**Your statutory rights are not affected.**

### **Warrantee**

The warrantee is the first/original buyer and/or any person who received a newly purchased product as a gift from the original buyer.

### **Warranty period**

The warranty periods, shown on our web shop, begin on delivery of the fitness equipment. The respective warranty periods for your equipment can be found on its product website.

### **Repair Costs**

According to our choice, there will either be a repair, a replacement of individual damaged parts or a complete replacement. Spare parts, that have to be mounted while assembling the equipment, have to be replaced by the warrantee personally and are not a part of repair. After the expiration of the warranty period, the responsibility for parts costs, repair costs, installation costs and delivery costs lies with the warranty holder.

### **The terms of use are defined as follows:**

- + Home use: solely for private use in private households up to 3 hours per day
- + Semi-professional use: up to 6 hours per day (e. g. rehabilitation centres, hotels, clubs, company gyms)
- + Professional use: more than 6 hours per day (e. g. commercial gyms)

### **Warranty Service**

Within the warranty period, equipment which develops faults as a result of material or manufacturing defects, will be repaired or replaced at our discretion. Ownership of equipment or parts of equipment which have been replaced is transferred to us. The warranty period is not extended nor does a new warranty period begin following repair or replacement under the warranty.

## **Warranty Conditions**

For the warranty to be valid, the following steps must be taken:

Please contact our customer service by email or phone. If the product under warranty has to be sent in for repair, the seller bears costs. After expiry of the warranty, the buyer bears the costs of transport and insurance. If the fault is covered by our warranty, you will receive a new or repaired equipment in return.

### **Warranty claims are invalid in case of damage resulting from:**

- + misuse or improper handling
- + environmental influences (moisture, heat, electrical surge, dust, etc.)
- + failure to follow the current safety measures for the equipment
- + failure to follow the operating instructions
- + use of force (e. g. hitting, kicking, falling)
- + interventions which were not carried out by one of our authorized service centres
- + unauthorised repair attempts

### **Proof of Purchase and Serial Number**

Please make sure that you are able to provide the appropriate receipt when claiming on your warranty. So that we can clearly identify the model of your equipment, and for the purposes of our quality control, you will need to give the serial number of your equipment, when contacting the service team. Where possible please have your serial number and your customer number ready when you call our service hotline. It will help us to deal with your request swiftly.

If you cannot find the serial number on your fitness equipment, our service team is at your disposal to offer further information.







































### **Service outside of the Warranty Period**

We are also happy to issue an individual cost estimate if there is a problem with your fitness equipment after the warranty has expired, or in cases which do not fall under the terms of the warranty, e. g. normal wear and tear. Please contact our customer service team to find a quick and cost-effective solution to your problem. In such a case you will be responsible for the delivery costs.

### **Communication**

Many problems can be solved just by speaking to us as your specialist supplier. We know how important it is to you as a user of the fitness equipment to have problems solved quickly and simply, so you can enjoy working out with minimal interruption. For that reason, we also want to resolve your queries quickly and in a straightforward manner. Thus, please always keep your customer number and the serial number of the faulty equipment handy.

## 10 CONTACT

DE	DK	UK
<p><b>TECHNIK</b></p> <p> +49 4621 4210-900</p> <p> +49 4621 4210-698</p> <p> <a href="mailto:technik@fitshop.de">technik@fitshop.de</a></p> <p> Öffnungszeiten entnehmen Sie unserer Homepage.</p>	<p><b>TEKNIK OG SERVICE</b></p> <p> 80 90 16 50</p> <p>+49 4621 4210-945</p> <p> <a href="mailto:info@fitshop.dk">info@fitshop.dk</a></p> <p> Åbningstider kan findes på hjemmesiden: <a href="https://stg.fit/statit7">https://stg.fit/statit7</a></p>	<p><b>CUSTOMER SUPPORT</b></p> <p> 00800 2020 2772</p> <p>+494621 4210 944</p> <p> <a href="mailto:info@fitshop.co.uk">info@fitshop.co.uk</a></p> <p> You can find the opening hours on our homepage: <a href="https://stg.fit/statitc">https://stg.fit/statitc</a></p>
<p><b>SERVICE</b></p> <p> 0800 20 20277 (kostenlos)</p> <p> 04621 4210 - 0</p> <p> <a href="mailto:info@fitshop.de">info@fitshop.de</a></p> <p> Öffnungszeiten entnehmen Sie unserer Homepage: <a href="https://stg.fit/statita">https://stg.fit/statita</a></p>	<p><b>FR</b></p> <p><b>TECHNIQUE &amp; SERVICE</b></p> <p> +33 (0) 189 530984</p> <p>+49 4621 42 10 933</p> <p> <a href="mailto:info@fitshop.fr">info@fitshop.fr</a></p> <p> Vous trouverez les heures d'ouverture sur notre site Internet: <a href="https://stg.fit/statit4">https://stg.fit/statit4</a></p>	<p><b>BE</b></p> <p><b>TECHNIQUE &amp; SERVICE</b></p> <p> 02 732 46 77</p> <p>+49 4621 4210 933</p> <p> <a href="mailto:info@fitshop.be">info@fitshop.be</a></p> <p> Vous trouverez les heures d'ouverture sur notre site Internet: <a href="https://stg.fit/statit8">https://stg.fit/statit8</a></p>
<p><b>ES</b></p> <p><b>TECNOLOGÍA Y SERVICIOS</b></p> <p> 911 238 029</p> <p> <a href="mailto:info@fitshop.es">info@fitshop.es</a></p> <p> Consulta nuestro horario de apertura en la página web: <a href="https://stg.fit/statit5">https://stg.fit/statit5</a></p>	<p><b>NL</b></p> <p><b>TECHNISCHE DIENST &amp; SERVICE</b></p> <p> +31 172 619961</p> <p> <a href="mailto:service@fitshop.nl">service@fitshop.nl</a></p> <p> De openingstijden vindt u op onze homepage: <a href="https://stg.fit/statit3">https://stg.fit/statit3</a></p>	<p><b>INT</b></p> <p><b>TECHNICAL SUPPORT &amp; SERVICE</b></p> <p> +49 4621 4210-944</p> <p> <a href="mailto:service-int@fitshop.de">service-int@fitshop.de</a></p> <p> You can find the opening hours on our homepage: <a href="https://stg.fit/statita">https://stg.fit/statita</a></p>
<p><b>PL</b></p> <p><b>DZIAŁ TECHNICZNY I SERWIS</b></p> <p> 22 307 43 21</p> <p>+49 4621 42 10-948</p> <p> <a href="mailto:info@fitshop.pl">info@fitshop.pl</a></p> <p> Godziny otwarcia można znaleźć na stronie głównej: <a href="https://stg.fit/statit6">https://stg.fit/statit6</a></p>	<p><b>AT</b></p> <p><b>TECHNIK &amp; SERVICE</b></p> <p> 0800 20 20277 (Freecall)</p> <p>+49 4621 42 10-0</p> <p> <a href="mailto:info@fitshop.at">info@fitshop.at</a></p> <p> Öffnungszeiten entnehmen Sie unserer Homepage: <a href="https://stg.fit/statitb">https://stg.fit/statitb</a></p>	<p><b>CH</b></p> <p><b>TECHNIK &amp; SERVICE</b></p> <p> 0800 202 027</p> <p>+49 4621 42 10-0</p> <p> <a href="mailto:info@fitshop.ch">info@fitshop.ch</a></p> <p> Öffnungszeiten entnehmen Sie unserer Homepage: <a href="https://stg.fit/statit9">https://stg.fit/statit9</a></p>

Please find a detailed overview including address and opening hours for all stores of the Fitshop Group in Germany and abroad on the following website:

[www.fitshop.com/en/stores](http://www.fitshop.com/en/stores)

# WE LIVE FITNESS

## WEBSHOP AND SOCIAL MEDIA

Fitshop is Europe's largest specialist store for home fitness equipment with currently over 70 stores and one of the world's most renowned online mail order companies for fitness equipment. Private customers order via the 25 web shops in the respective national language or have their desired equipment assembled on site. In addition, the company supplies fitness studios, hotels, sports clubs, companies and physio practices with professional equipment for endurance and strength training.

Fitshop offers a wide range of fitness equipment from renowned manufacturers, high-quality in-house developments and comprehensive services, such as a build-up service and sports scientific advice before and after the purchase. The company employs numerous sports scientists, fitness trainers and competitive athletes.

Visit us also on our social media platforms or our blog!

	<a href="http://www.fitshop.co.uk">www.fitshop.co.uk</a> <a href="http://www.fitshop.de/blog">www.fitshop.de/blog</a>
---	--

	<a href="http://www.facebook.com/fitshop.co.uk">www.facebook.com/fitshop.co.uk</a>
---	--

	<a href="http://www.instagram.com/fitshop_uk">www.instagram.com/fitshop_uk</a>
--	--

	<a href="http://www.youtube.com/@fitshop_uk">www.youtube.com/@fitshop_uk</a>
---	--

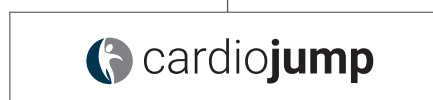



Notes

Notes



**TAURUS<sup>®</sup>**

**Indoor Cycle Z9PRO**