

TAURUS®

Assembly and Operating Instructions

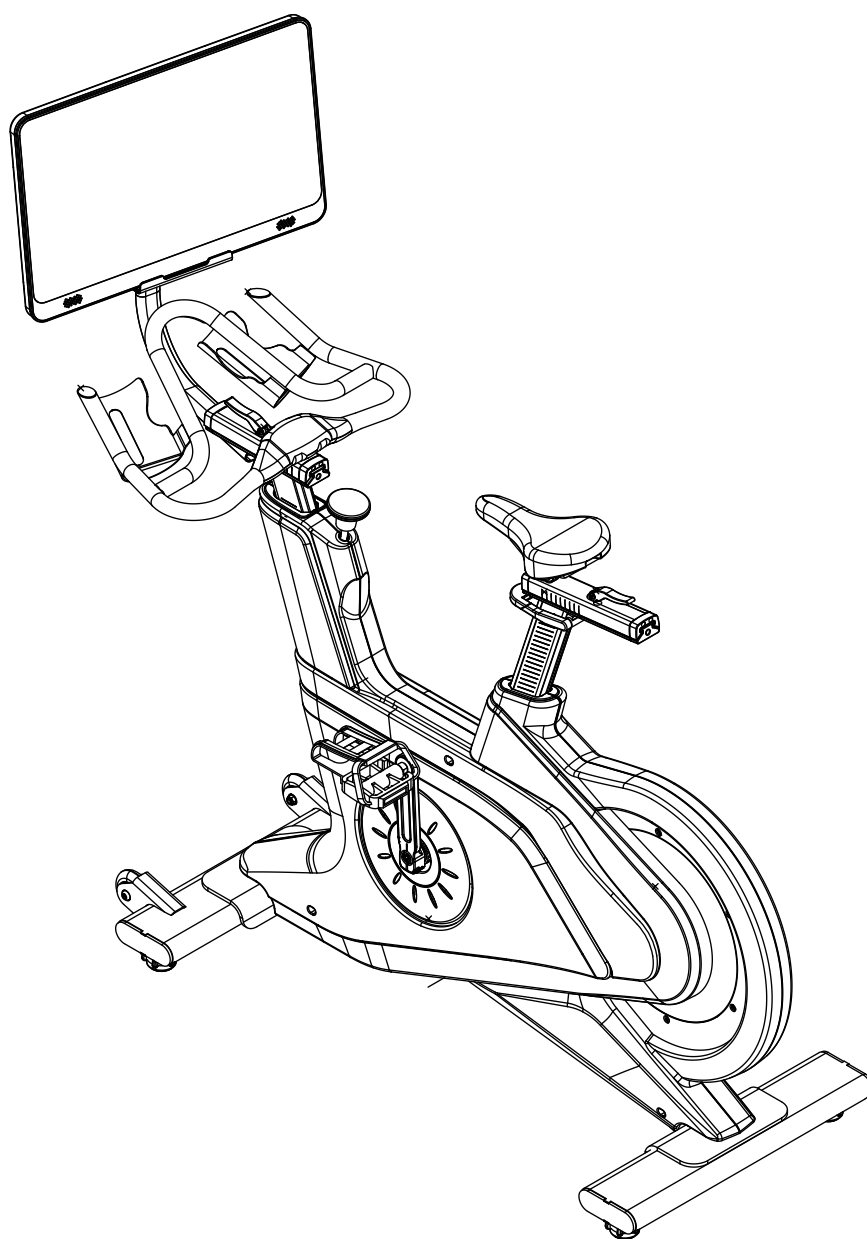

max. 150 kg



~ 60 Min.



66 kg

L 153 | W 52 | H 158

FSTFZ99PRO21.01.03

Art. No. TF-Z99PRO-21

Taurus Smart Bike Z9.9 Pro

Content

1	GENERAL INFORMATION	8
1.1	Technical Data	8
1.2	Personal Safety	9
1.3	Electrical Safety	10
1.4	Set-Up Place	11
2	ASSEMBLY	12
2.1	General Instructions	12
2.2	Scope of Delivery	13
2.3	Assembly	15
3	OPERATING INSTRUCTIONS	25
3.1	Console Display	25
3.2	Button Functions	26
3.3	Further Functions	27
3.4	Programmes	28
3.4.1	Quick-Start Programme/Target Programme	29
3.4.2	Pre-set Programmes	30
3.4.3	Interval Programme	31
3.4.4	Heart Rate Controlled Programmes	32
3.4.5	Watt Programme	34
3.4.6	Virtual Training Routes	35
3.5	Workout tips	38
3.5.1	Training clothes	38
3.5.2	Warming up and stretching	38
3.5.3	Medication	39
3.5.4	Used muscle groups	39
3.5.5	Exercise frequency	39
3.6	Workout journal	41
3.7	Multimedia and Software Updates	42
4	STORAGE AND TRANSPORT	44
4.1	General Instructions	44
4.2	Transportation Wheels	44
5	TROUBLESHOOTING, CARE AND MAINTENANCE	45
5.1	General Instructions	45
5.2	Faults and Fault Diagnosis	45

5.3	Error Codes and Troubleshooting	46
5.4	Maintenance and Inspection Calendar	47
6	DISPOSAL	47
7	RECOMMENDED ACCESSORIES	48
8	ORDERING SPARE PARTS	49
8.1	Serial Number and Model Name	49
8.2	Parts List	50
8.3	Exploded Drawing	53
9	WARRANTY	55
10	CONTACT	57

Dear customer,

Thank you for choosing quality training equipment from the TAURUS® brand. Taurus offers sports and fitness equipment for home users with high demands on quality, functionality and longevity. Also, Taurus is a well-known and experienced brand for equipping professional rooms for fitness studios and business customers. The focus of Taurus fitness equipment is on what matters most in sports: maximum performance! Therefore, the devices are developed in close consultation with athletes and sports scientists. Because athletes know best what makes perfect fitness equipment.

Further information can be found at www.fitshop.com.

Intended Use

The equipment may only be used for its intended purpose.

The equipment is suitable for home use and semi-professional use (e.g. hospitals, clubs, hotels, schools, etc.). The equipment is not suitable for commercial or professional use (e.g. fitness studio).

Legal Notice

Fitshop GmbH
Europe's No. 1 for home fitness

International Headquarters
Flensburger Straße 55
24837 Schleswig
Germany

Management:
Christian Grau
Sebastian Campmann
Dr. Bernhard Schenkel
No. HRB 1000 SL
Local Court Flensburg
European VAT Number: DE813211547

Disclaimer

© TAURUS is a registered brand of the company Fitshop GmbH. All rights reserved. Any use of this trademark without the explicit written permission of Fitshop is prohibited.

Product and manual are subject to change. Technical data can be changed without advance notice.

FITSHOP

Europe's No.1 for Home Fitness

ABOUT THIS MANUAL

Please carefully read the entire manual before installation and first use. The manual will help you to quickly set up the system and explains how to safely use it. Make sure that all persons exercising with the equipment (especially children and persons with physical, sensory, mental or motor disabilities) are informed about this manual and its contents in advance. In case of doubt, responsible persons must supervise the use of the equipment.

Due to ongoing changes and software optimisations, the manual may have to be updated. If you notice any discrepancies during assembly or use, please refer to the manual uploaded to the webshop. The latest manual is always available there.



This equipment has been manufactured according to the latest safety knowledge. As far as possible, potential safety hazards which could cause injury have been eliminated. Make sure to carefully follow the instructions and that all parts are securely in place. If required, read through the instructions again to correct any mistakes.

Training devices must be classified according to accuracy and use. Accuracy classes are only applicable to devices that display training data.

Accuracy classes

Class A: high accuracy.

Class B: medium accuracy.

Class C: low accuracy.

The use classes explain the intended use of the training device.

Use classes

Class S (studio): professional and/or commercial use.

These training devices are intended for the use in training rooms of facilities such as sports clubs, school facilities, hotels, clubs and studios whose access and supervision is specifically regulated by the owner (person with legal responsibility).

Class H (home use): use at home.

These stationary training devices are intended for the use in private homes where access to the training device is regulated by the owner (person with legal responsibility).

Please pay close attention to the safety and maintenance instructions given here. The contract partner cannot be held liable for damage to health, accidents or damage to the equipment when it is not used in accordance with these instructions.

The following safety instructions may appear in this manual:

► **ATTENTION**

This notice indicates potentially hazardous situations which, if not avoided, may result in property damage.

⚠ **CAUTION**

This notice indicates potentially hazardous situations which, if not avoided, may result in slight or minor injuries!

⚠ **WARNING**

This notice indicates potentially hazardous situations which, if not avoided, may result in death or serious injuries!

⚠ **DANGER**

This notice indicates potentially hazardous situations which, if not avoided, will result in death or serious injuries!

ⓘ **NOTICE**

This notice indicates further useful information.

Retain these instructions in a safe place for future reference, maintenance or when ordering replacement parts.

**Check your TFT console regularly for possible software updates.
If available, make sure to carry out the updates.**

1.1 Technical Data

TFT Display of

- + Speed in km/h
- + Rotations per minute
- + Training time in min
- + Training distance
- + Calorie consumption in kcal
- + Heart rate (when using the chest strap)
- + Watt

Resistance system: electrical magnetic brake system
Resistance levels: 32
Flywheel mass: 15 kg

Wattage
Min. and max. Watt at 60 RPM: 25-330 W
Min. and max. Watt at 100 RPM: 53-750 W
Adjustable range in the Watt programme: 20-350 W

Total training programmes: 20
Quick Start programmes: 1
Target programmes: 1
Pre-set programmes: 12
Interval programmes: 1
HRC programmes: 4
Watt programmes: 1

Weight and Dimensions:

Article weight (gross, incl. packaging) approx.: 73 kg
Article weight (net, without packaging) approx.: 66 kg
Packaging dimensions (L x W x H) approx.: 126 cm x 33 cm x 90 cm
Set up dimensions (L x W x H) approx.: 153 cm x 52 cm x 158 cm

Maximum user weight: 150 kg
Use class: S

1.2 Personal Safety

DANGER

- + Before you start using the equipment, you should consult your physician that this type of exercise is suitable for you from a health perspective. Particularly affected are persons who: have a hereditary disposition to high blood pressure or heart disease, are over the age of 45, smoke, have high cholesterol values, are overweight and/or have not exercised regularly in the past year. If you are under medical treatment that affects your heart rate, medical advice is absolutely essential.
- + Note that excessive training can seriously endanger your health. Please also note that heart rate monitoring systems can be inaccurate. If you notice any signs of weakness, nausea, dizziness, pain, shortness of breath, or other abnormal symptoms, stop exercising immediately and seek advice from your doctor if necessary.
- + The owner must communicate all warnings and instructions to the user.

WARNING

- + This equipment may not be used by children under the age of 14.
- + Children should not be allowed unsupervised access to the equipment.
- + Persons with disabilities must have a medical license and must be under strict observation when using the equipment.
- + The equipment is strictly for use by one person at a time.
- + If your equipment provides a safety key, the clip of the safety key must be attached to your clothing before starting your training. In the event of a fall, the EMERGENCY STOP of the equipment can be initiated.
- + There is a risk of injury from spinning pedals and/or an exposed flywheel in the absence of a freewheel. Never get on or off the equipment when the pedals or the flywheel are still moving. Always make sure that the pedals and the flywheel have come to a complete stop.
- + Support yourself with at least one hand on the handlebar when getting on and off the equipment. Only dismount from the equipment when the pedals have come to a complete stop.
- + Keep your hands, feet and other body parts, hair, clothing, jewellery and other objects well clear of moving parts.
- + During use, wear suitable sports clothing rather than loose or baggy clothing. When wearing sports shoes, make sure they have suitable soles, preferably made of rubber or other non-slip materials. Shoes with heels, leather soles, studs or spikes are unsuitable. Never exercise barefoot.

CAUTION

- + If your equipment needs to be connected to the power supply with a mains cable, make sure that the cable is not a potential tripping hazard.
- + Make sure that nobody is within the range of motion of the equipment during training so as not to endanger you or other persons.
- + Always tighten the pedal strap before you start training to prevent your feet from slipping.

 **CAUTION**

- + Be aware that if adjustment devices are left protruding, they may impede the user's movement.

 **ATTENTION**

- + Do not insert any objects of any kind into the openings of the device.
- + To protect the equipment from use by unauthorised third parties, always remove the power cable when not in use and store it in a safe place that is inaccessible to unauthorised persons (e.g. children).
- + Class B and C crank training equipment is not suitable for high accuracy purposes.

1.3 Electrical Safety

 **DANGER**

- + In order to reduce the risk of an electric shock, always unplug the equipment from the mains socket immediately after your workout, before assembly or dismantling, and before maintenance or cleaning. Do not pull on the cable.

 **WARNING**

- + Do not leave the equipment unattended while the mains cable is plugged into the mains socket. During your absence, the mains cable must be removed from the mains socket to prevent improper use by third parties or children.
- + If the mains cable or plug is damaged or defective, contact your contract partner. Until repair, the equipment must not be used.

 **ATTENTION**

- + The equipment requires a mains connection of 220-230 V with 50 Hz mains voltage.
- + The equipment may only be connected directly to an earthed socket using the supplied mains cable. Extension cables must conform to VDE guidelines. Always completely unwind the mains cable.
- + The socket must be protected by a fuse with a minimum fuse rating of "16 A, slow blow".
- + Do not make any changes to the mains cable or the mains plug.
- + Keep the mains cable away from water, heat, oil and sharp edges. Do not route the mains cable underneath the equipment or under a carpet or rug, and do not place any objects on top of it.
- + If your purchased item is equipped with a TFT console, software updates must be carried out regularly. Follow the instructions on the console to perform the update(s).
- + The software systems on gym equipment with TFT consoles are set up only for the pre-installed apps. Do not install any additional apps.

 **NOTICE**

- + The pre-installed apps on TFT consoles are produced and provided by external manufacturers. Fitshop does not take any responsibility for the availability, functionality or contents of these apps.
- + Hereby, Fitshop GmbH declares that the radio equipment type Wireless Connection (2.402 – 2.480 GHz) complies with Directive 2014/53/EU. The full text of the EU Declaration of Conformity is available at the following website: www.fitshop.com.

1.4 Set-Up Place

WARNING

- + Do not place the equipment in main corridors or escape routes.

CAUTION

- + Choose a location in which to place the equipment such that there is enough free space/clearance to the front, the rear and to the sides of the equipment.
- + The training room should be well ventilated during training and not be exposed to any draughts.
- + Choose the place in which to set up the equipment such that there is enough free space/clearance to the front, the rear and to the sides of the equipment.
- + The free area in the direction from which the exercise equipment is accessed must be at least 0.6 m larger than the exercise area.
- + The set-up and mounting surface of the equipment should be flat, loadable and solid.

ATTENTION

- + The device may only be used in one building, in sufficiently tempered and dry rooms (ambient temperatures between 10°C and 35°C). The equipment should not be used outdoors or in rooms with high humidity (over 70%) like swimming pools.
- + A floor protective mat/equipment underlay can help to protect high-quality floor coverings (parquet, laminate, cork, carpets) from dents and sweat and can help to level out slight unevenness.
- + For Class S equipment, the exercise equipment may only be used in areas where access, supervision and control are specifically regulated by the owner.

2.1 General Instructions



DANGER

- + Do not leave any tools, packaging materials such as foils or small parts lying around, as otherwise there is a danger of suffocation for children. Keep children away from the equipment during assembly.



WARNING

- + Pay attention to the instructions attached to the equipment in order to reduce the risk of injuries.



CAUTION

- + Ensure to have sufficient room for movement in each direction during assembly.
- + The assembly of the equipment must be carried out by at least two adults. If in doubt, seek the help of a third technically skilled person.



ATTENTION

- + To prevent damage to the equipment and the floor, assemble the equipment on a mat or packaging board.



NOTICE

- + In order to make the assembly as simple as possible, some screws and nuts to be used can already be pre-assembled.
- + Ideally, assemble the equipment at its later set-up place.

2.2 Scope of Delivery



The scope of delivery consist of the following parts. At the beginning, check whether all parts and tools belonging to the device are included in the scope of delivery and whether damage has occurred. In the event of complaints, the contractual partner must be contacted directly.

CAUTION

If parts of the scope of delivery are missing or damaged, the assembly must not be carried out.

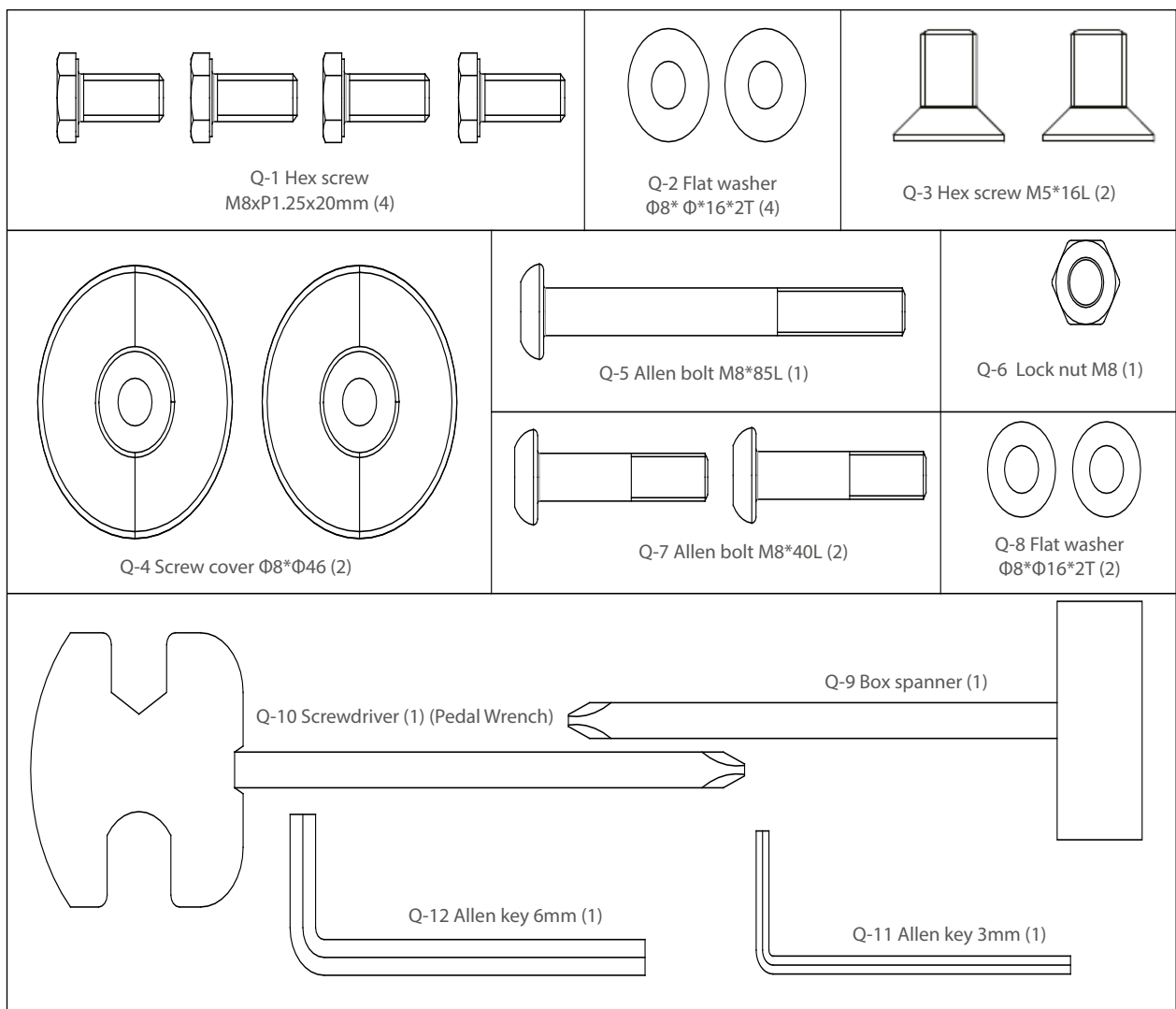
Hardware pack

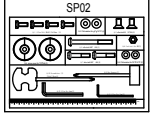
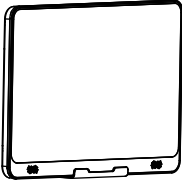
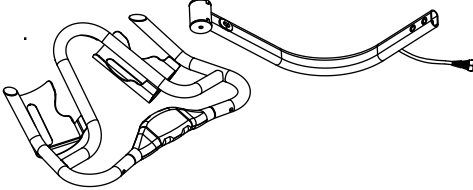
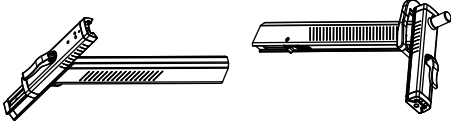

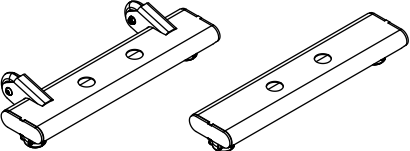
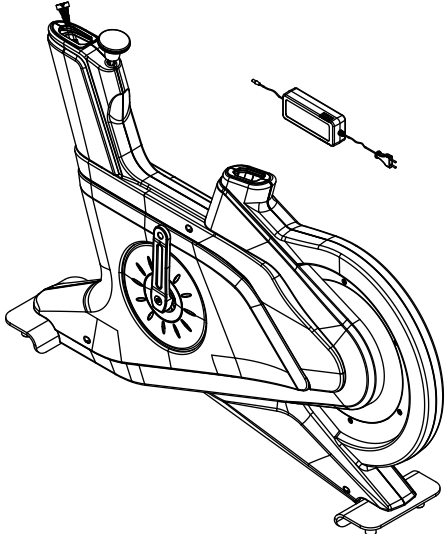
	<p>Manual</p>	
		<p>A</p>
		<p>B-1 / E-1</p>
		<p>C / O-1</p>
		<p>D-1 / P-11</p>
		<p>L-35L / L-35R</p>
		<p>M / N</p>
		<p>L / R</p>

2.3 Assembly

Before assembly, take a close look at the individual assembly steps shown and carry out the assembly in the order given.

NOTICE

- + First loosely screw all parts together and check that they fit properly. Tighten the screws using the tool only when you are instructed to do so.
- + If you have difficulty recognising the graphics, we recommend that you open and/or download the PDF instructions stored in the webshop on your end device (e.g. smartphone, tablet or PC). There you have the option of zooming in closer. Please note that the Adobe Acrobat Reader programme must be installed on your end device in order to open the file.

Step 1: Assembly of the Front and Rear Stabilizer

1. Mount the front stabilizer (M) and rear stabilizer (N) to the main frame (L) with two hex screws (Q-1) and two flat washers (Q-2) each.
2. Tighten the screws with the tool.

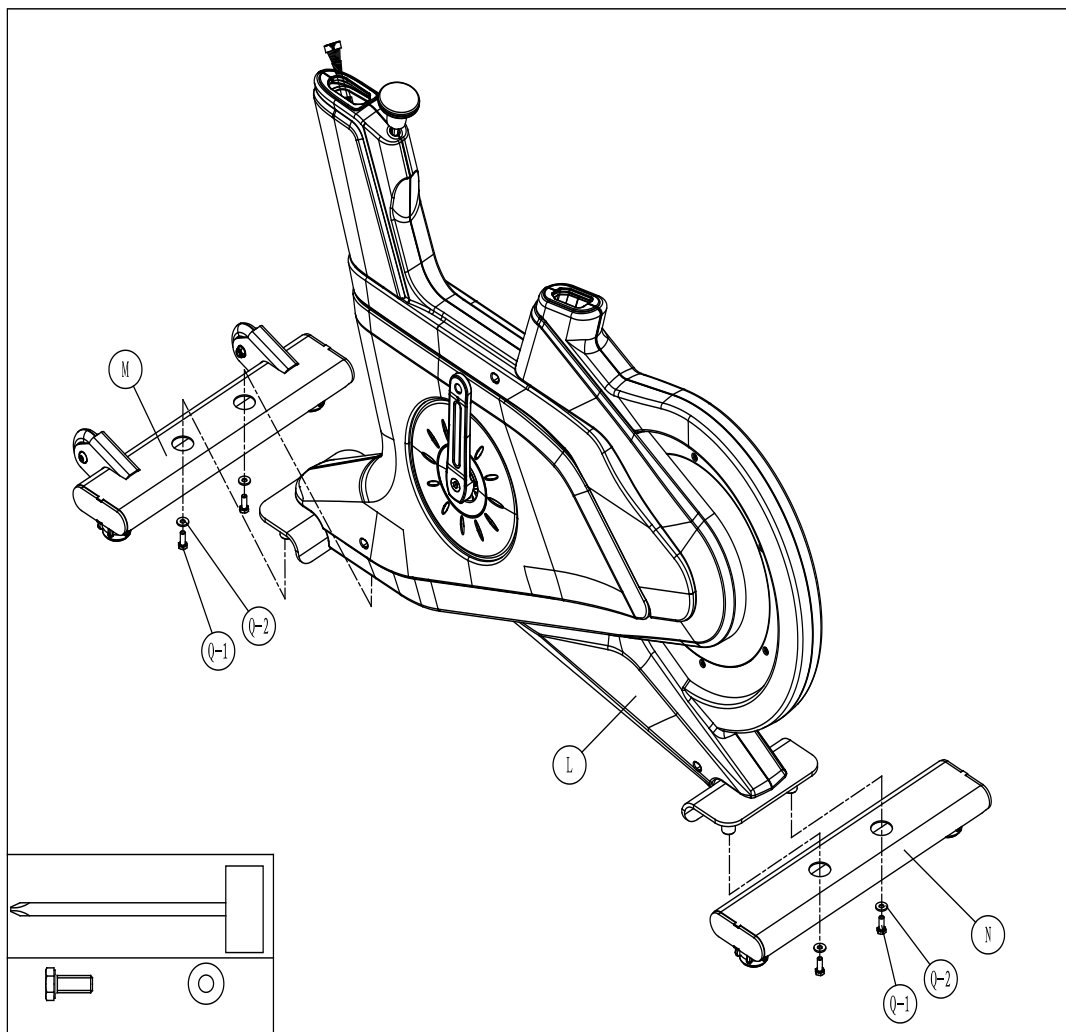

Step 2: Assembly of the Pedals

CAUTION

Make sure to screw in the pedals completely.

1. Screw the right pedal (L-35R) into the thread of the pedal axis located on the right side of the main frame by turning it clockwise.
2. Screw the left pedal (L-35L) into the thread of the pedal axis located on the left side of the main frame by turning it counter clockwise.
3. Tighten the pedals (L-35R / L35-L) with the tool.

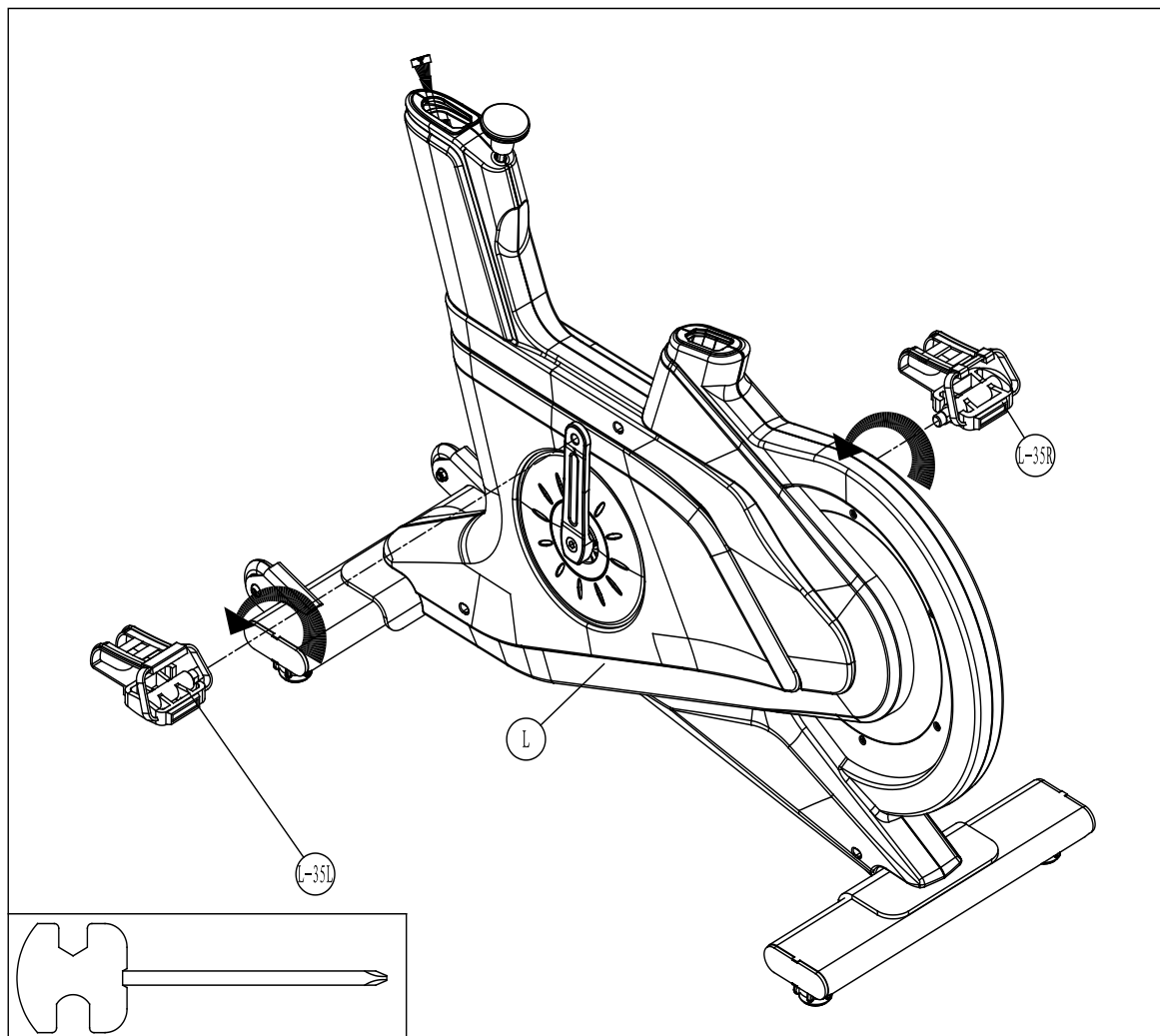

Step 3: Assembly of the Seat Post and Seat

1. Insert the seat post (O-1) into the main frame (L).
2. Attach the seat (P-11) to the seat post (O-1).
3. Tighten the pre-assembled screw connection on the underside of the seat (P-11) with the tool.

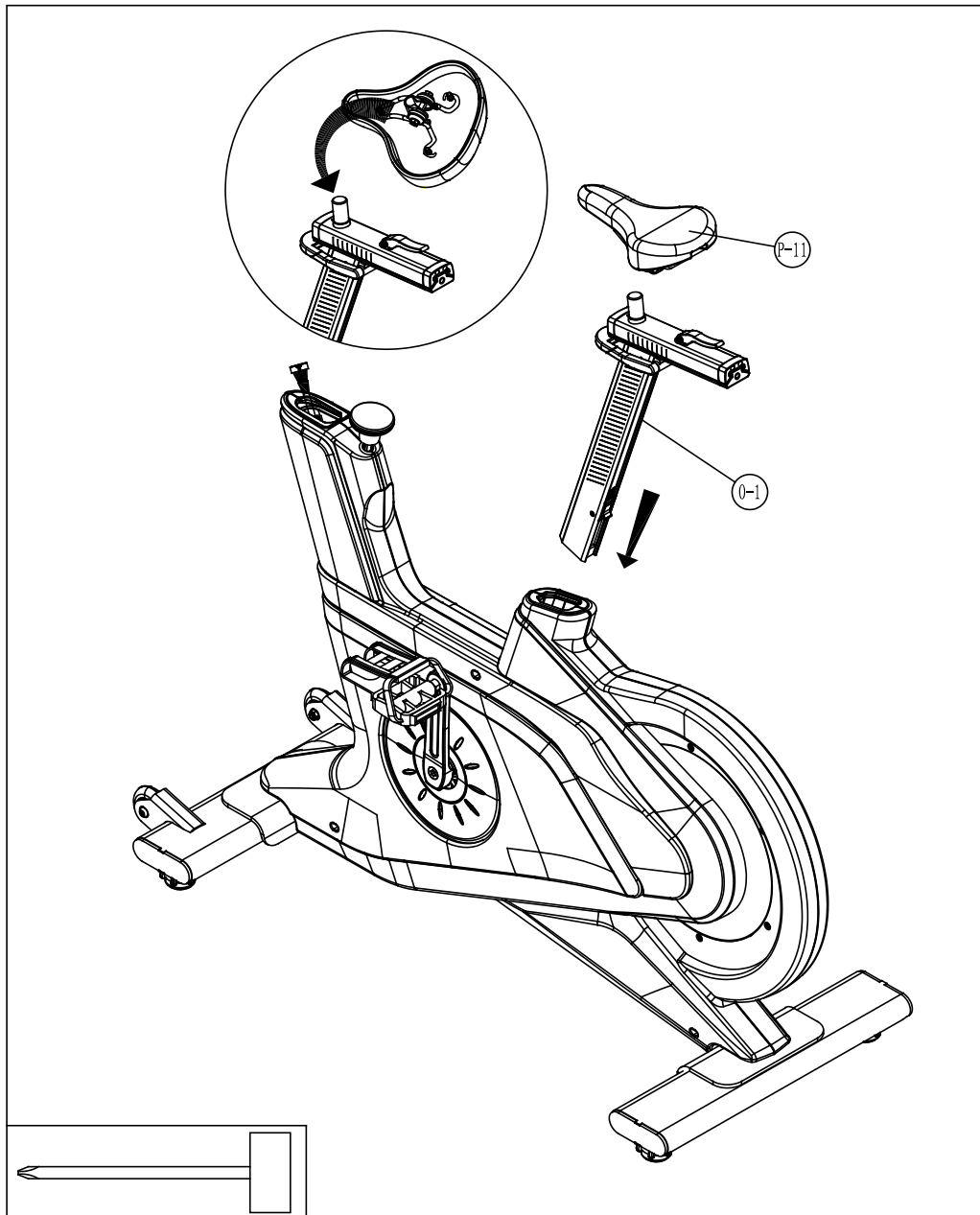

Step 4: Assembly of the Handlebar

1. Remove the pre-assembled screw (C-2) and limit piece (C-5).
2. Loosen the pull pin (B-5) and slide out the upper slider (B-4).
3. Attach the handlebar (B-1) to the upper slider (B-4) with two hex screws (Q-3) using the tool (fig. 1).
4. Slide the handlebar into position as shown in fig. 2.
5. Secure the limit piece (C-5) and the lower cover (C-1) with the previously removed screw (C-2) using the tool (fig. 3).

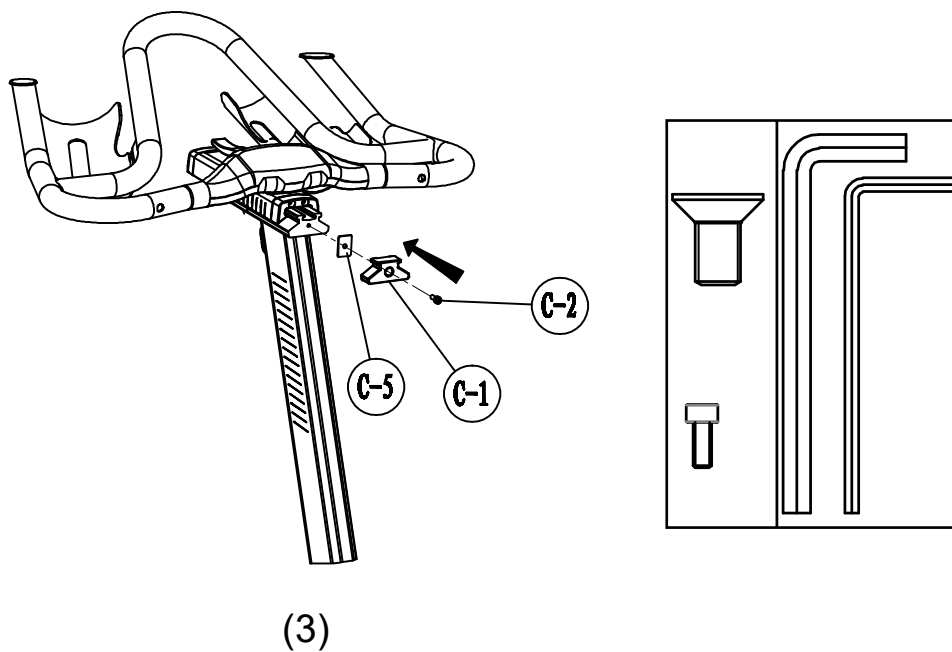
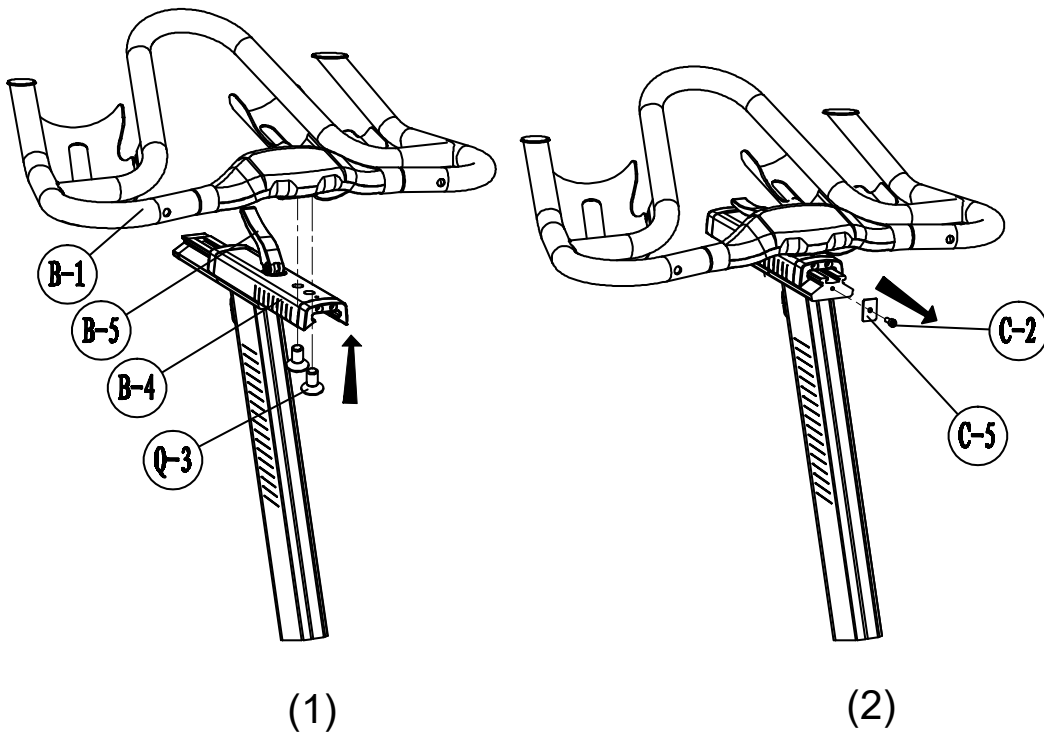

Step 5: Assembly of the Holder Tube

1. Carefully pull the cable (C-3) through the handlebar post (C).

► **ATTENTION**

Make sure not to pinch the cables during the following steps.

2. Mount the holder tube (E-1) to the the handlebar post (C) with two allen bolts (Q-7) and two flat washers (Q-8).
3. Tighten the bolts (Q-7) with the tool.

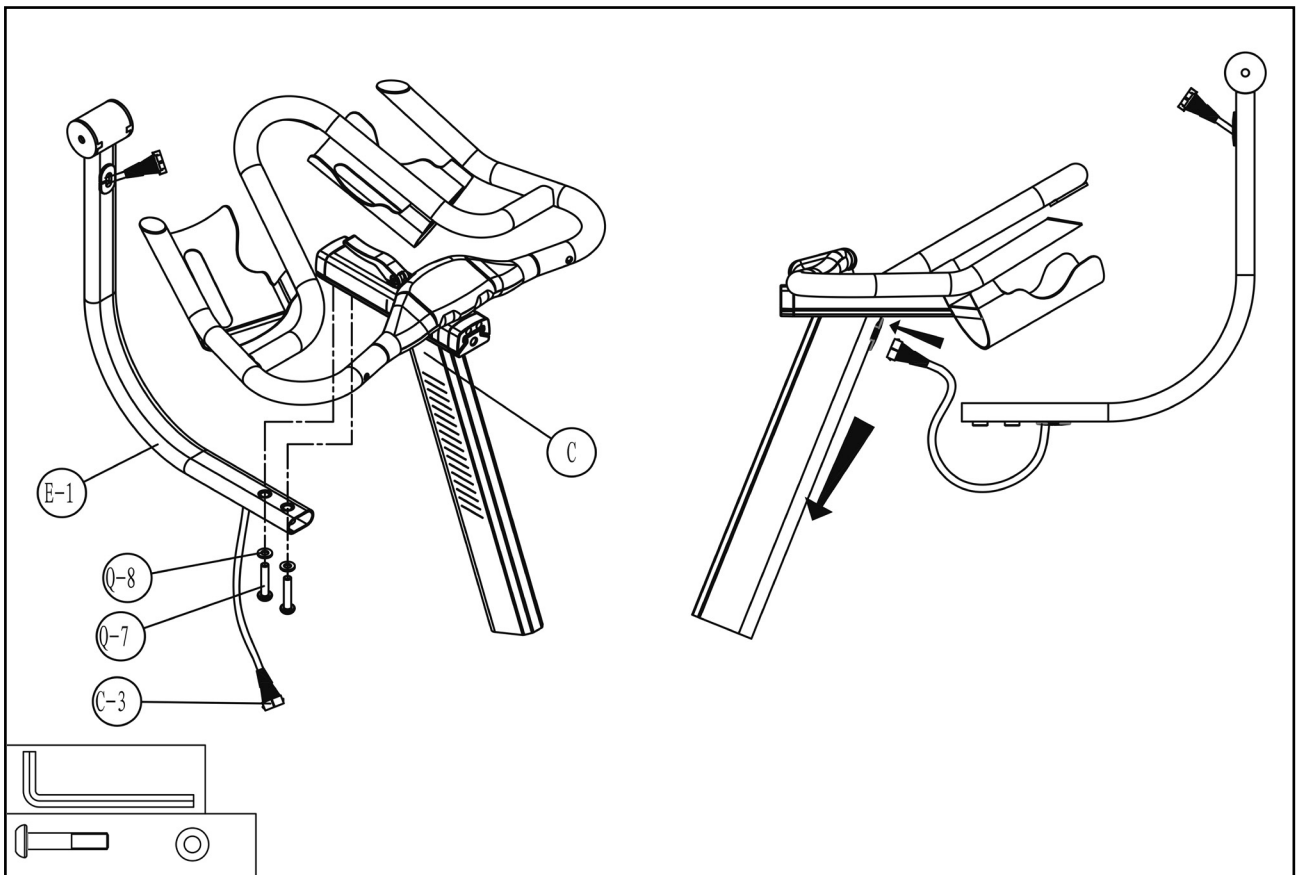

Step 6: Assembly of the Handlebar Post

1. Connect the cables C-3 and L-12.

► **ATTENTION**

Make sure not to pinch the cables during the following steps.

2. Attach the handlebar post (C) to the main frame (L).
3. Fixate the handlebar post (C) by turning the lever clockwise on the right side of the main frame (L).

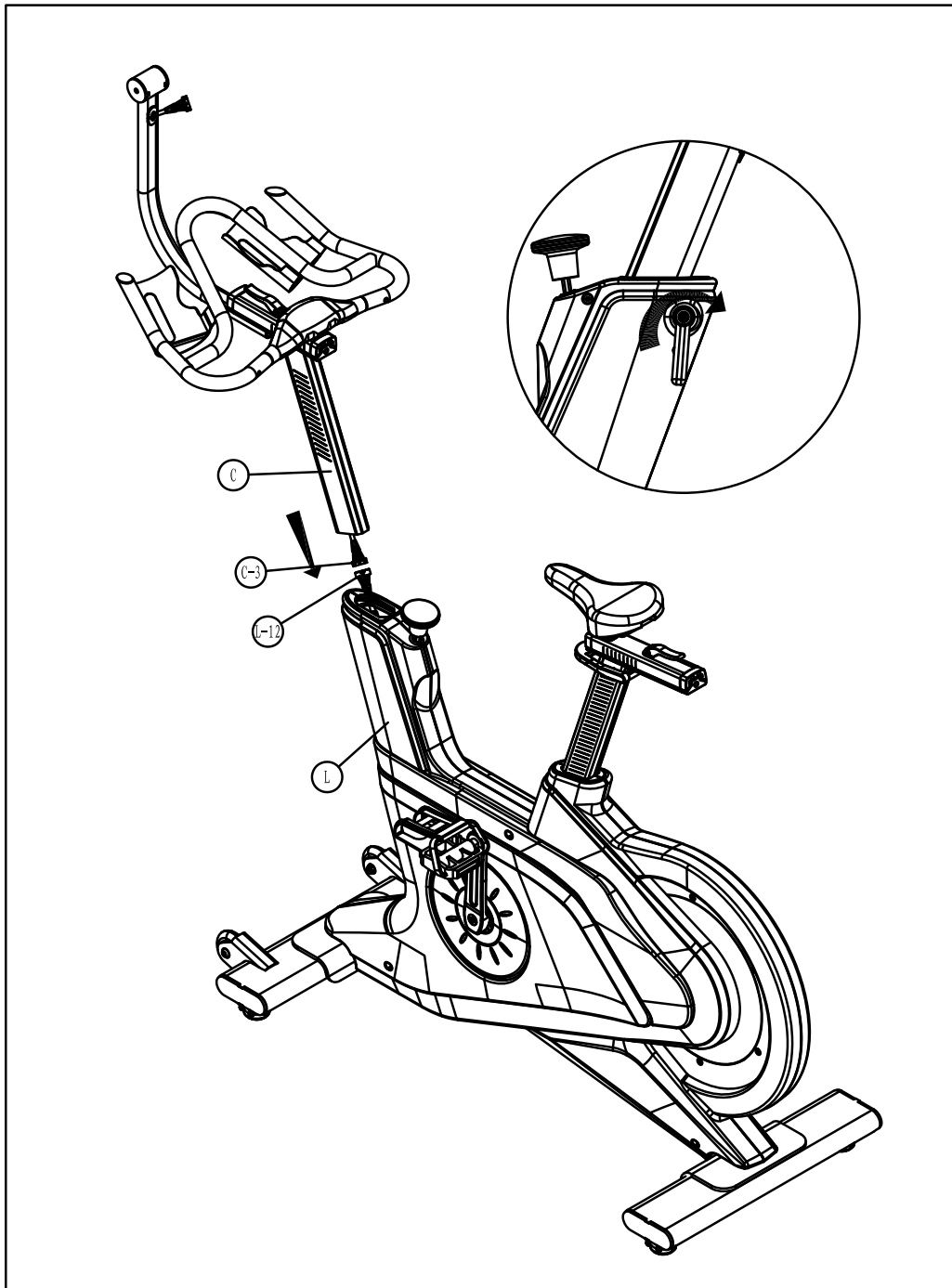

Step 7: Assembly of the Console Support

1. Mount the console support (D-1) to the top of the holder tube (E-1) with one allen bolt (Q-5), two screw covers (Q-4) and one nut (Q-6).
2. Tighten the screw connection with the tools.

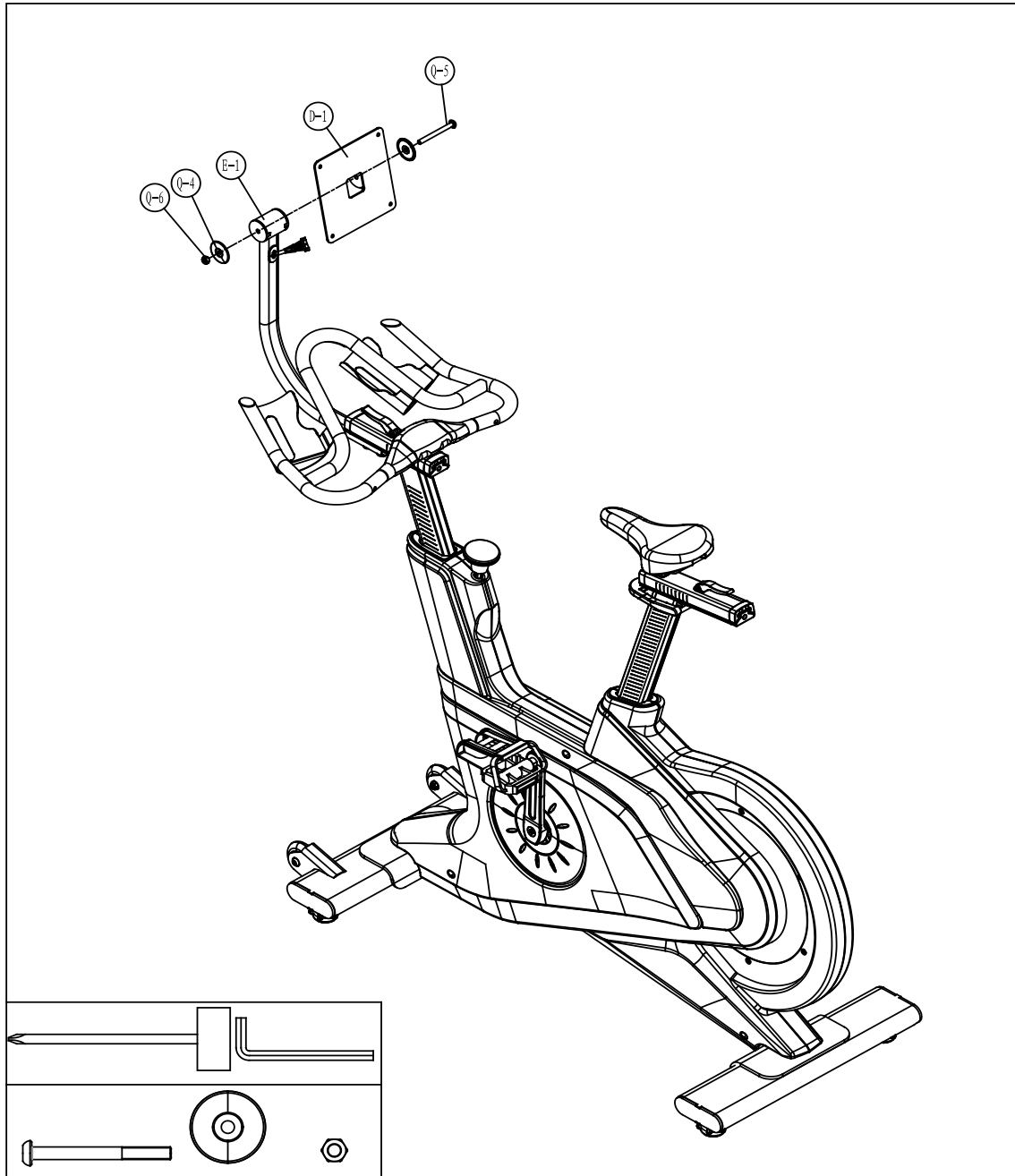

Step 8: Assembly of the Console

1. Remove the pre-assembled screws from the rear side of the console (A-1).
2. Connect the console cable to the cable of the console supporting bar.

ⓘ ATTENTION

Be careful not to pinch the cables during the following step.

3. Mount the console (A) to the console support (D-1) with the previously removed screws (A-1).
4. Tighten the screws (A-1) with the tool.

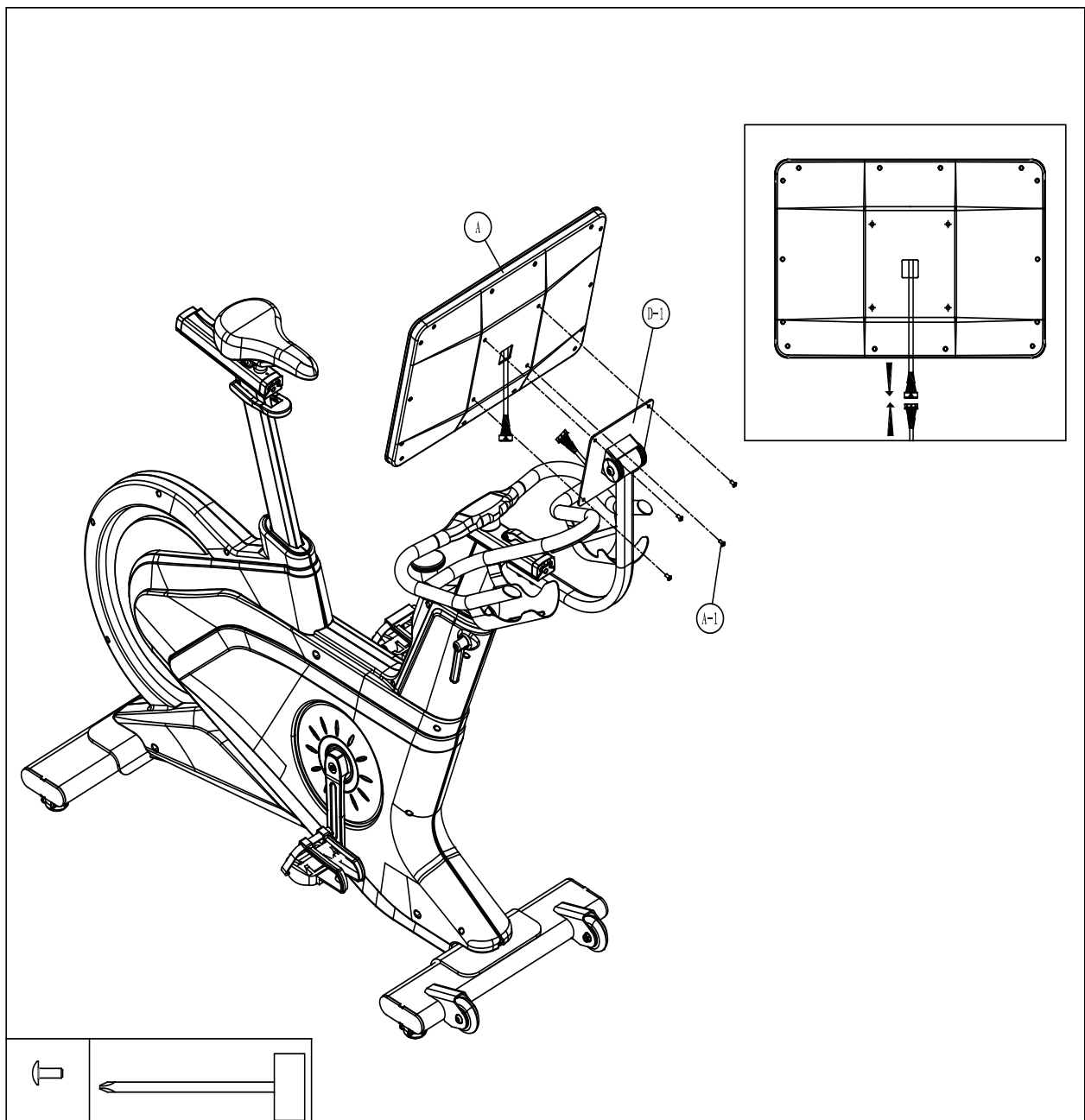

Step 9: Alignment of the Feet

If the floor is uneven, you can stabilize the equipment by turning the two setting screws under the main frame.

1. Lift the equipment on the desired side and rotate the setting screws under the main frame.
2. Rotate the screws clockwise in order to remove them and to raise the equipment.
3. Rotate them counterclockwise in order to lower the equipment.

Step 10: Connecting the Equipment to the Mains Supply

► ATTENTION

The equipment must not be connected to a multiple socket, otherwise it cannot be guaranteed that the equipment will be supplied with sufficient power. Technical errors can result.

Plug the power plug into a wall outlet that complies with the instructions in the chapter on electrical safety.

1. Connect the power supply (R) to the front of the main frame (L).
2. Plug the power supply into a socket that complies with the specifications of the electrical safety chapter 1.3.

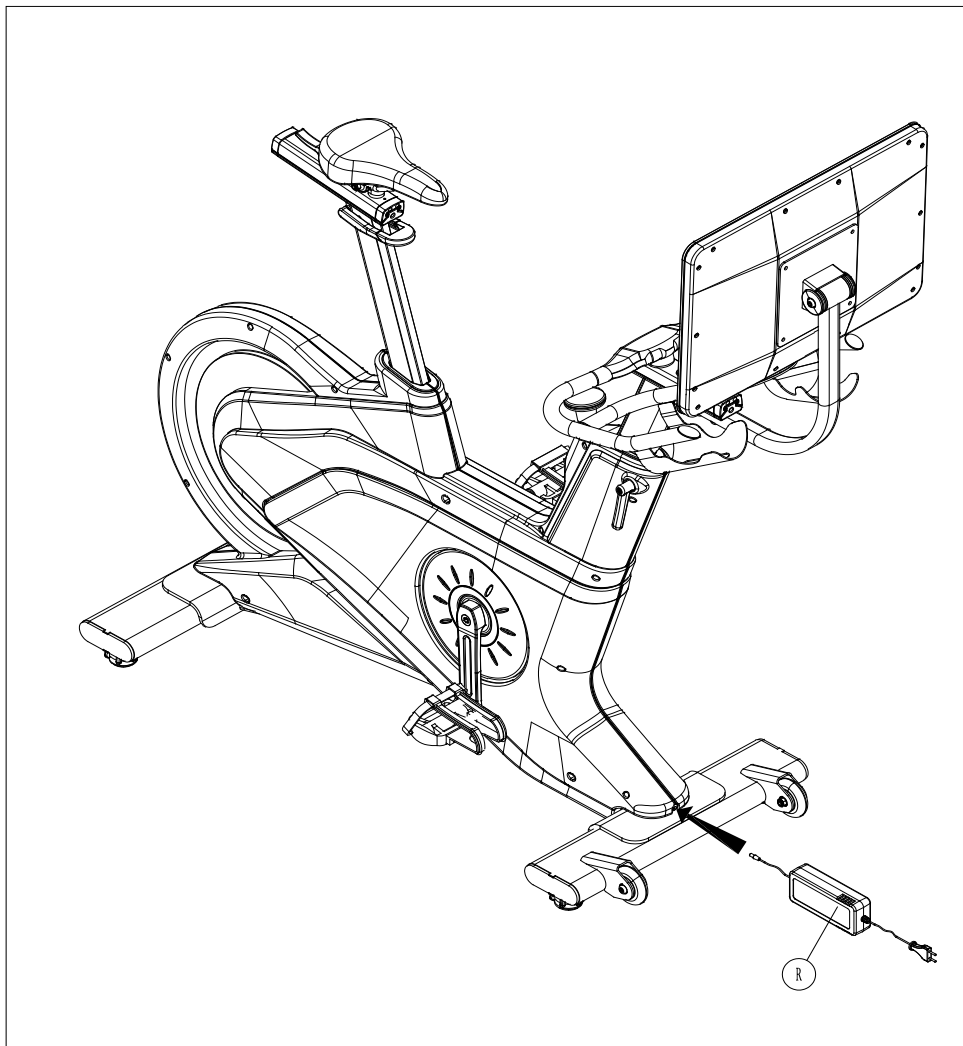

Correctly Getting On and Off

1. To get on, grip the handles with both hands and first step onto the left pedal with your left foot or onto the right pedal with your right foot and then place your foot onto the other pedal.
2. To get off, grip the handles with both hands and place one foot next to the equipment and then the other foot.

3 OPERATING INSTRUCTIONS

① NOTICE

- + Familiarise yourself with all the functions and setting options of the device before starting training. Have the proper use of this product explained to you by a specialist.
- + Always start your training with low intensity and increase evenly and gently. End your training with a cool-down phase. If you are unsure, please consult your physician.

3.1 Console Display

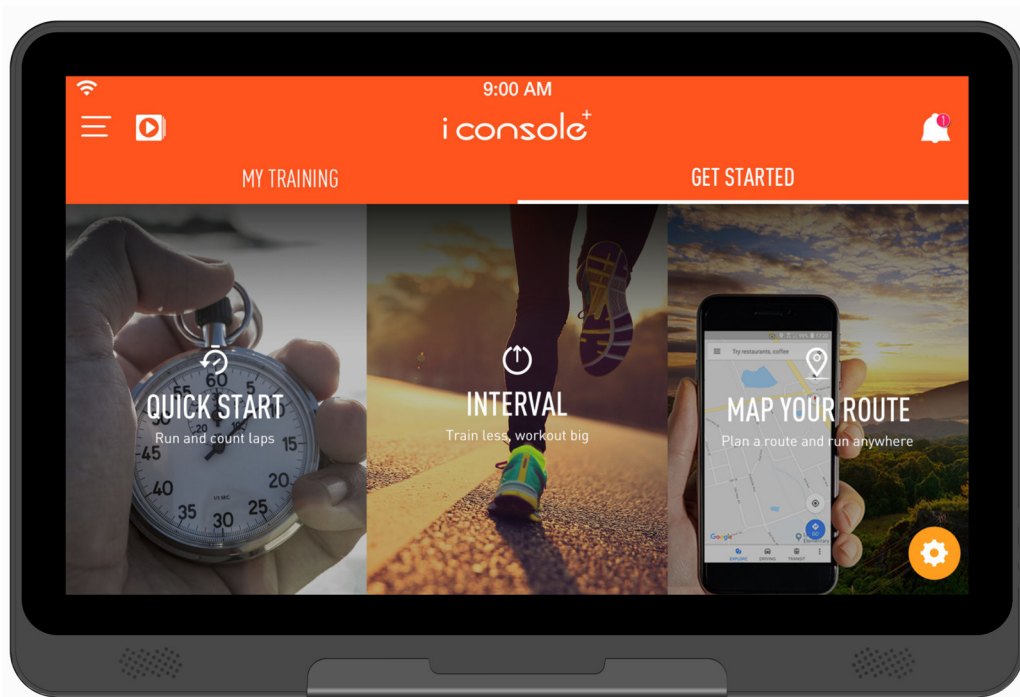





TIME	+ Display of the training time + Display range 0:00 - 99:99
SPEED	+ Display of the current speed
DISTANCE	+ Display of the training distance + Display range 0 - 99.9 km or mi
CALORIES	+ Display of the calorie consumption + Display range 0 - 9990 kcal

Heart Rate	<ul style="list-style-type: none"> + Display of the current heart rate + Display of the heart rate + Display range 0 - 230 <p>ⓘ NOTICE This equipment does not have hand pulse sensors. To measure the heart rate, a chest strap is required.</p>
WATT	<ul style="list-style-type: none"> + Display of the Watt value + Display range 0-999
HRZone	<ul style="list-style-type: none"> + Display of the heart rate zones + Display range very light, light, moderate, hard, maximum
BAI	<ul style="list-style-type: none"> + Display of the BAI consumption + Display range 0 - 999 <p>ⓘ NOTICE Body Activity Intelligence (BAI) is a universal and consistent metric that applies to all ages and genders. It evaluates whether your physical activity and training are sufficient for improving your overall health and physical condition.</p>
RPM	<ul style="list-style-type: none"> + Display of the current revolutions per minute (RPM) + Display range 0 - 999

3.2 Button Functions

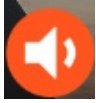
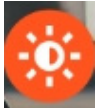
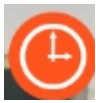
Start/Pause	+ Tap to start and/or pause the training
Stop	+ Tap to stop the training
Up	+ Tap to increase a value
Down	+ Tap to decrease a value

3.3 Further Functions

	Settings	Here you will find all setting options.
	Volume	Here you can adjust the volume.
	Brightness	Here you can adjust the brightness.
	Timezone	Here you can adjust the date or the current time zone.
	Wifi	Here you can connect the console to a wifi network.
	Heart Rate	Here you can connect the console to a chest strap.
	Multimedia	Here you can access different media: Netflix, Youtube, Spotify, Kinomap, Firefox, Facebook, Twitter Instagram

3.4 Programmes

There are a variety of programmes available to you. These include

- + Quick Start programme: 1
- + Target programme: 1
- + Pre-set programmes: 12
- + Interval programme: 1
- + Heart rate programmes: 4
- + Watt programme: 1

You can also set your own virtual training routes via Google Maps.

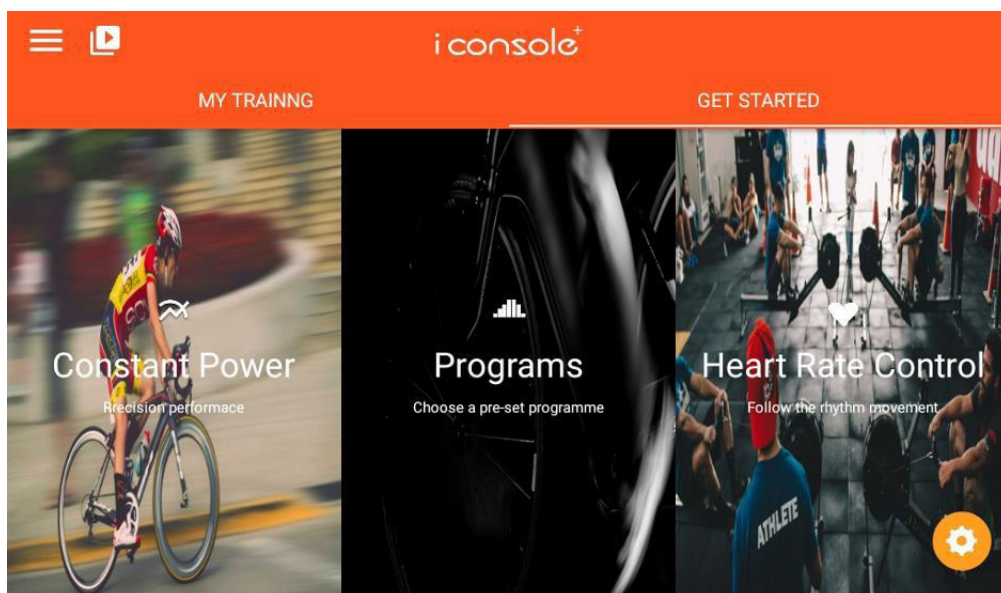
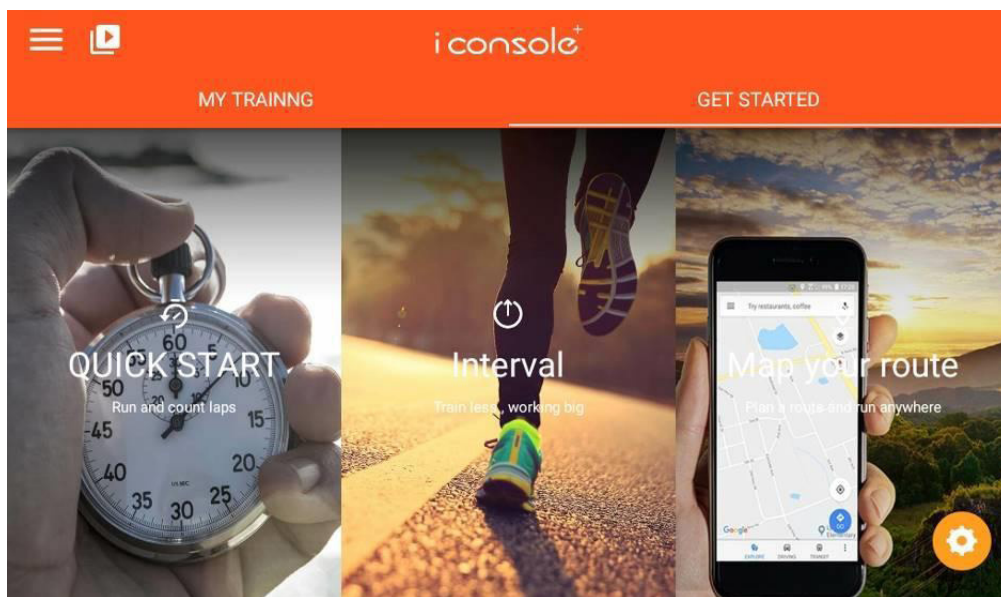

3.4.1 Quick-Start Programme/Target Programme

1. Tap QUICK START in the main menu.
2. Set the values for the desired distance, time and/or calories for your training.

NOTICE

You can set one or more parameters. The set values are counted down to 0, the others are counted up accordingly.

3. To start the training, tap START.

You can manually adjust the resistance during the workout.

4. To pause the training, tap PAUSE.
5. To stop the training, tap STOP.

→ *When the training is finished, a summary of the recorded training parameters is displayed.*

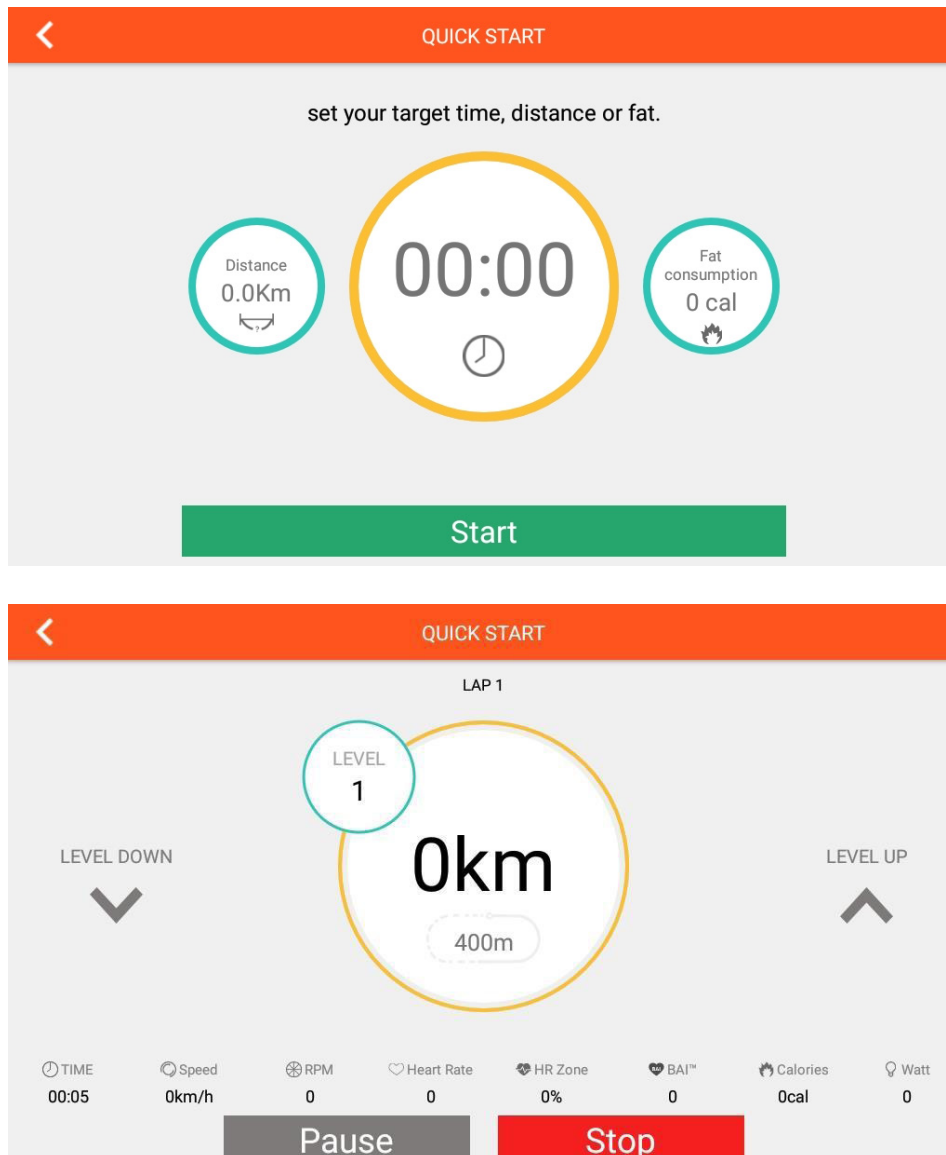

3.4.2 Pre-set Programmes

1. Tap PROGRAMS in the main menu.
2. Set the desired training time.
3. Select one of the 12 pre-set programmes.
4. To start the training, tap START.

You can manually adjust the resistance during the training.

5. To pause the training, tap PAUSE.
6. To stop the training, tap STOP.

→ *When the training is finished, a summary of the recorded training parameters is displayed.*

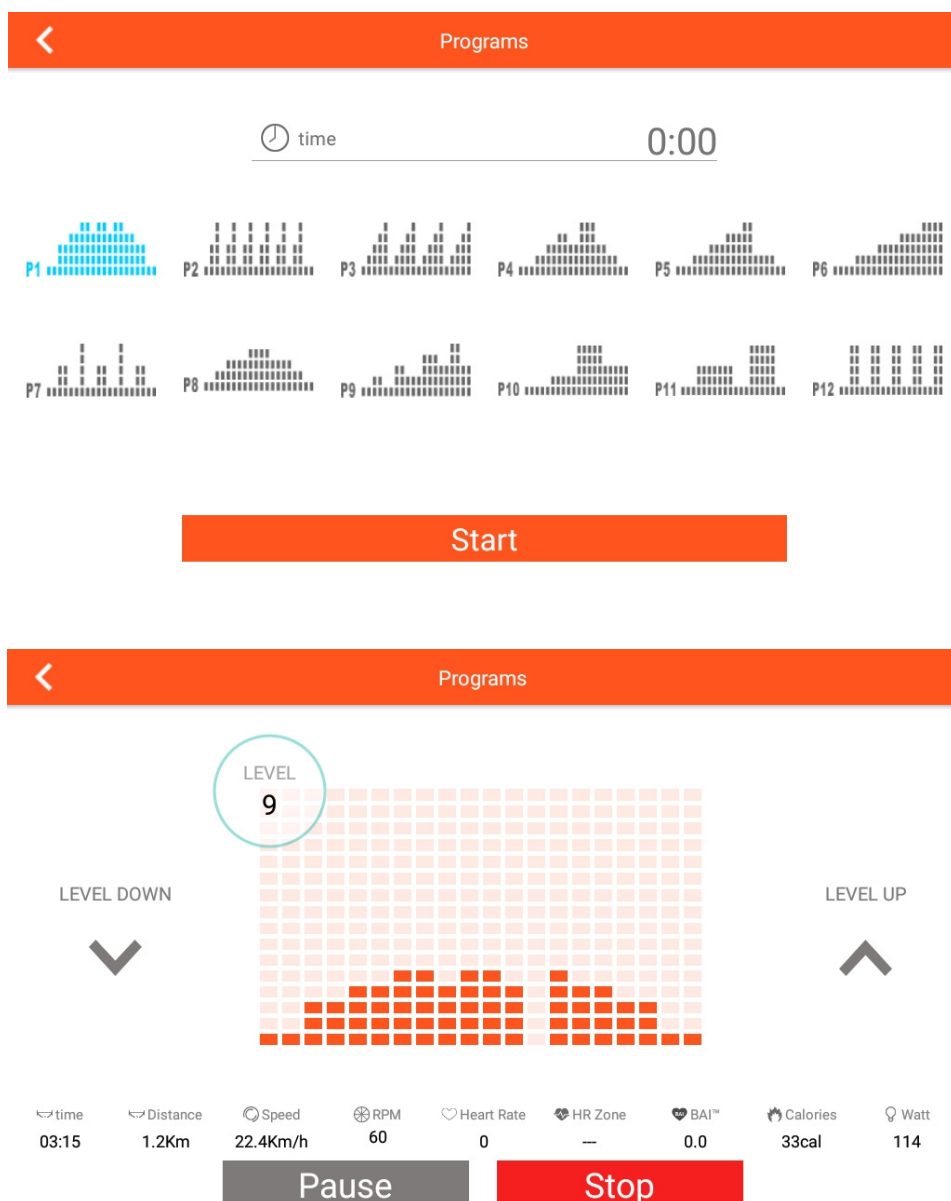

3.4.3 Interval Programme

1. Tap INTERVAL in the main menu.
2. Set the values for the desired number of cycles, time, resistance and revolutions per minute for your workout.
3. To start the training, tap START.

The workout starts with a 1-minute warm-up.

You can manually adjust the resistance during the training.

4. To pause the training, tap PAUSE.
5. To stop the training, tap STOP.

→ *When the training is finished, a summary of the recorded training parameters is displayed.*

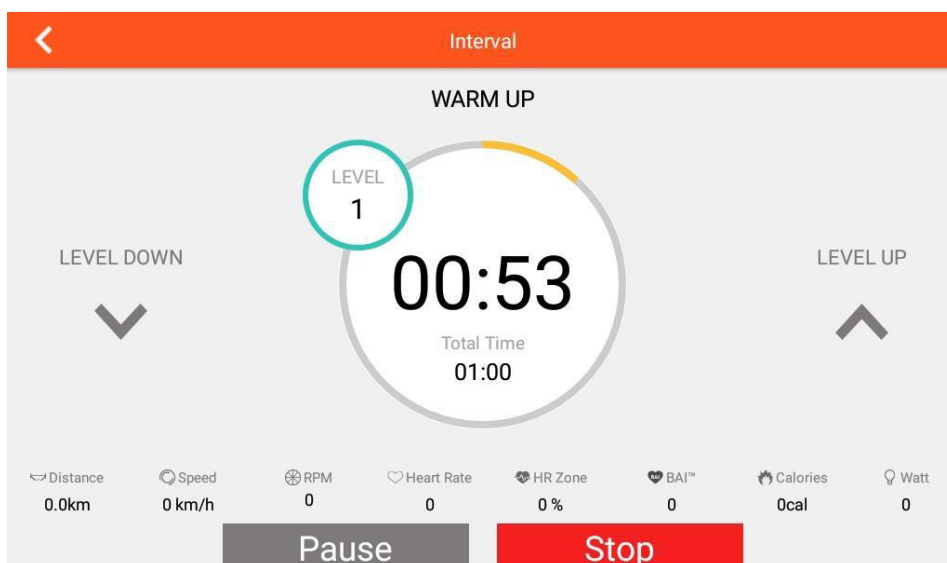
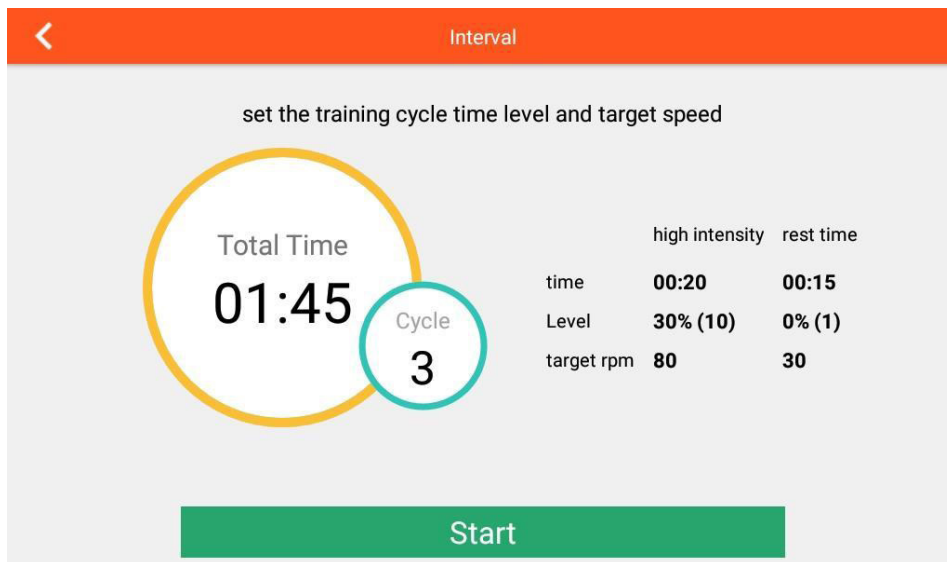

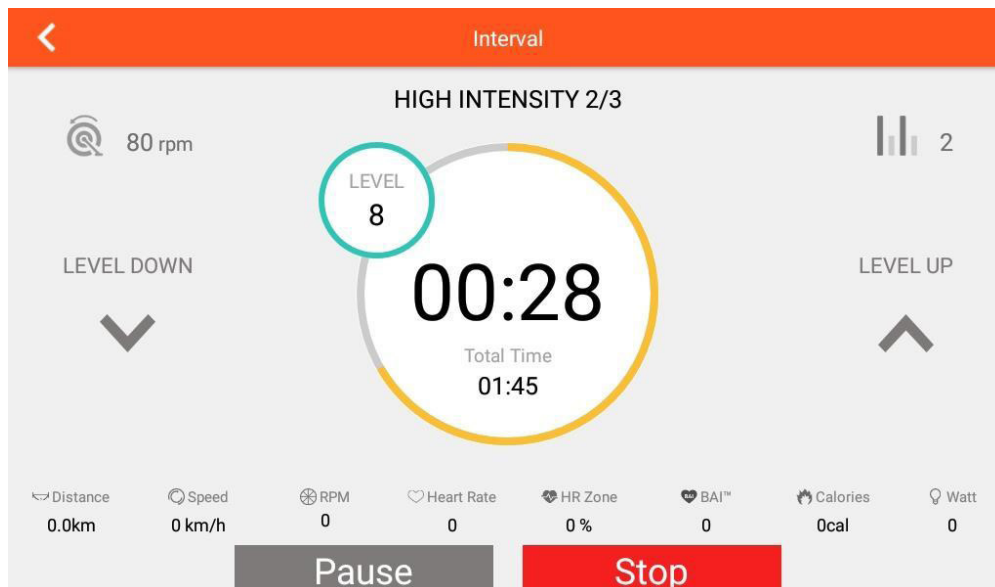

3.4.4 Heart Rate Controlled Programmes

WARNING

Your training equipment is not a medical device. The heart rate measurement of this equipment may be inaccurate. Various factors can affect the accuracy of the heart rate measurement. The heart rate measurement serves only as a training aid.

NOTICE

For this programme, a chest strap is required.

You can choose between three preset heart rate programmes and one programme, where you individually set a pulse value (55 %, 75 %, 90 % of your max. pulse and TAG PULSE).

In the heart rate programmes, the resistance is automatically adjusted depending on your heart rate. Your maximum heart rate is determined by the console depending on your entered age.

1. Tap HEART RATE CONTROL in the main menu.
2. Enter your age and the desired training time.
3. Select either 55%, 75%, 90% or Target Pulse.
- 3.1. If you selected Target Pulse, now set the desired pulse value.
4. To start the training, tap START.

The resistance is adjusted according to your heart rate. The resistance cannot be adjusted manually.

NOTICE

If the console does not receive a pulse signal for 30 seconds, the programme will automatically stop.

- 5. To pause the training, tap PAUSE.
- 6. To pause the training, tap STOP.

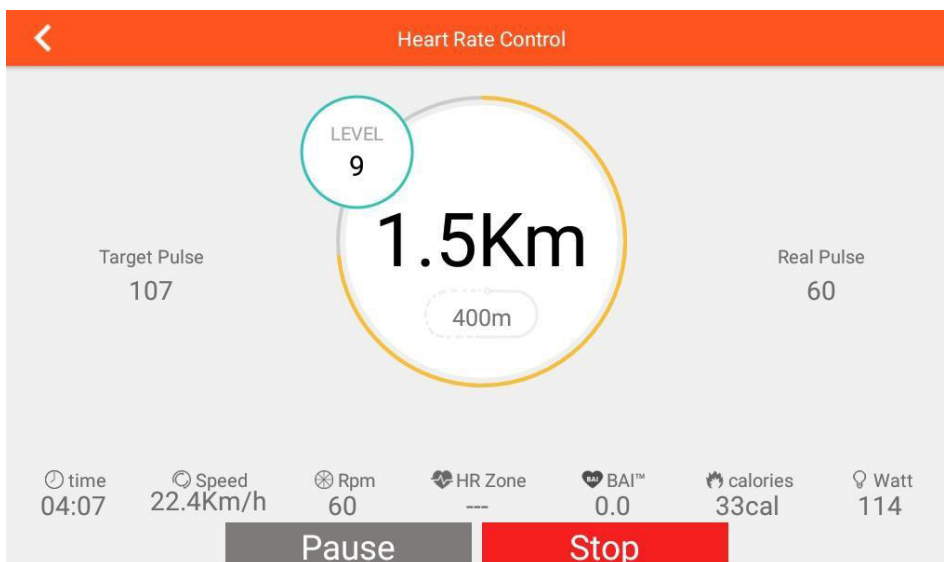
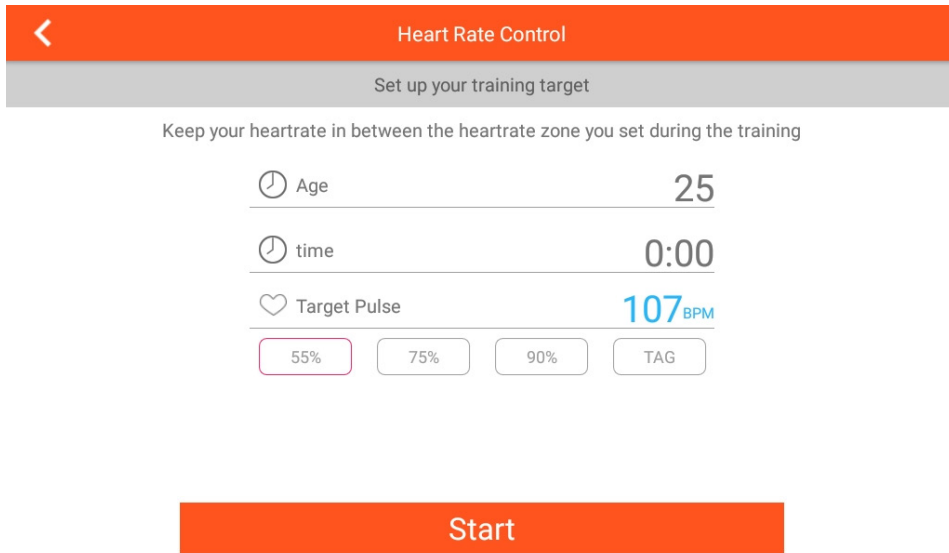

→ When the training is finished, a summary of the recorded training parameters is displayed.



3.4.5 Watt Programme

1. Tap CONSTANT POWER in the main menu.
2. Set the values for the desired training time, target wattage and target cadence for your training.
3. To start the training, tap START.

The resistance level is automatically adjusted according to the wattage you set.

4. To pause the training, tap the following icon .
5. To stop the training, tap the following icon .

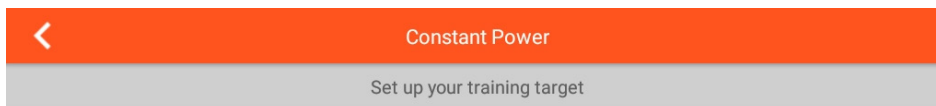

→ When the training is finished, a summary of the recorded training parameters is displayed.

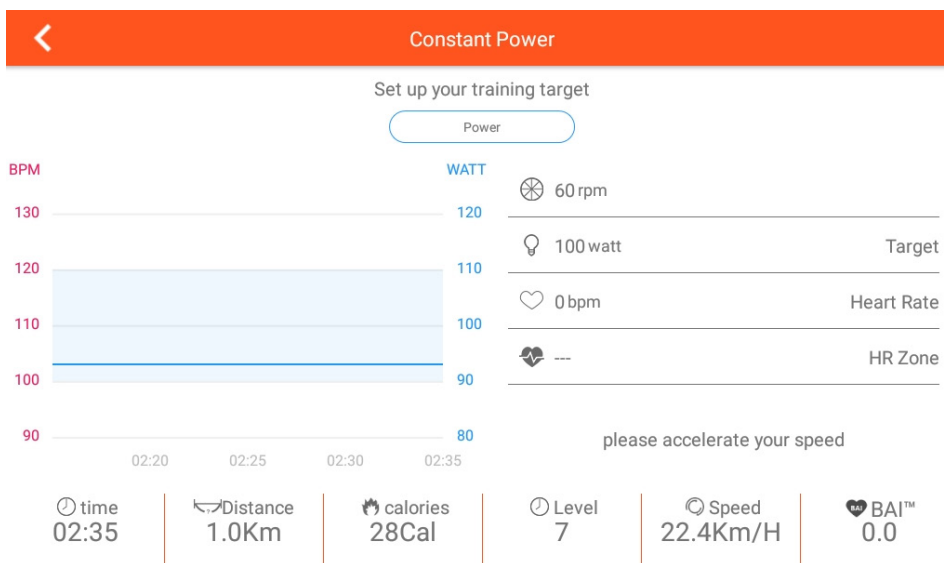

time 0:00
Target Power 100WATT









3.4.6 Virtual Training Routes



1. Tap MAP YOUR ROUTE in the main menu.
2. After you have started this mode, you must determine your current position. To do this, tap the following icon .
3. To switch to the worldwide Google Maps view, tap the following icon .

NOTICE

If you are within China, you can also select the default region by tapping the following icon .

4. Select your start position and tap until the following icon appears .
5. Select your end position and tap it again until the following icon appears .
6. If desired, select one or more stopovers on your route and tap a third (or correspondingly more) time(s) until the following icon appears .
7. To cancel your selection, tap the following icon .
8. To start the training, swipe the following icon from left to right .
9. To show or hide the training parameters, tap the following icon .
10. To switch between the map view, Google Street View and the satellite view, tap the following icon .

The resistance level is automatically adjusted according to the condition of the track. Alternatively, you can adjust the resistance level manually during the workout.

11. To pause the training, tap the following icon .
12. To end the training, tap the following icon .

→ *When the training is finished, a summary of the recorded training parameters is displayed.*

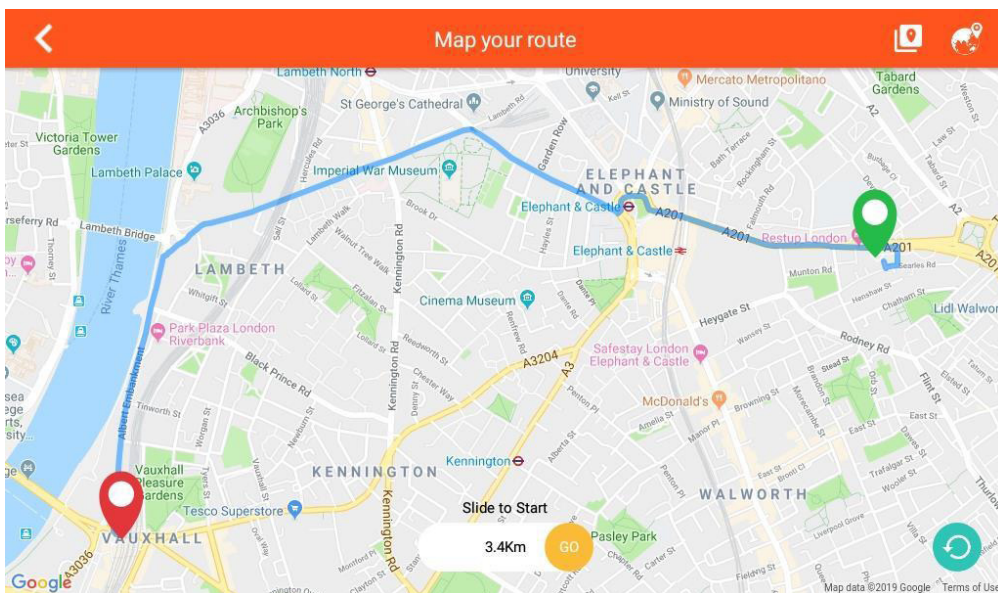
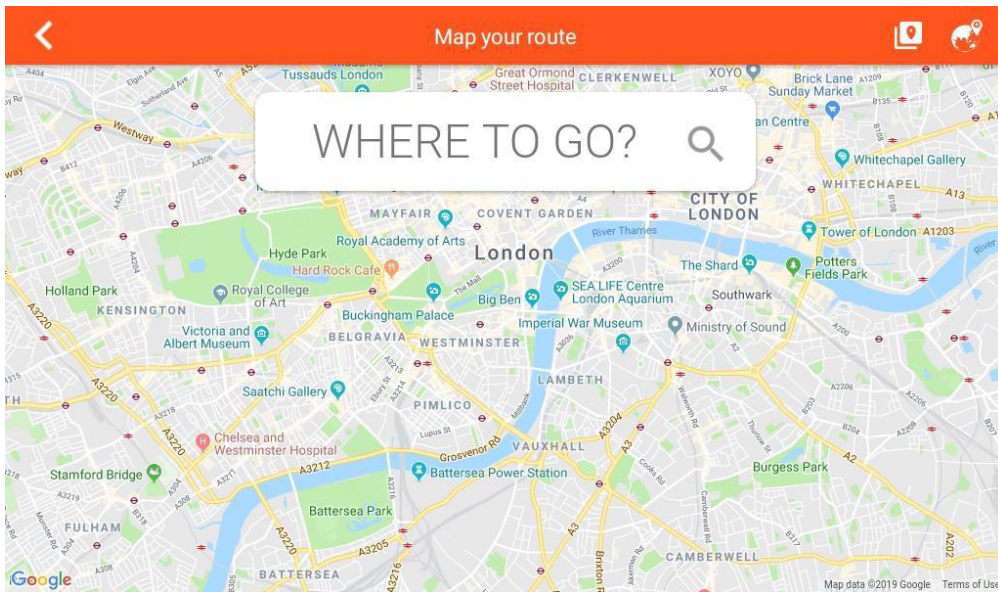

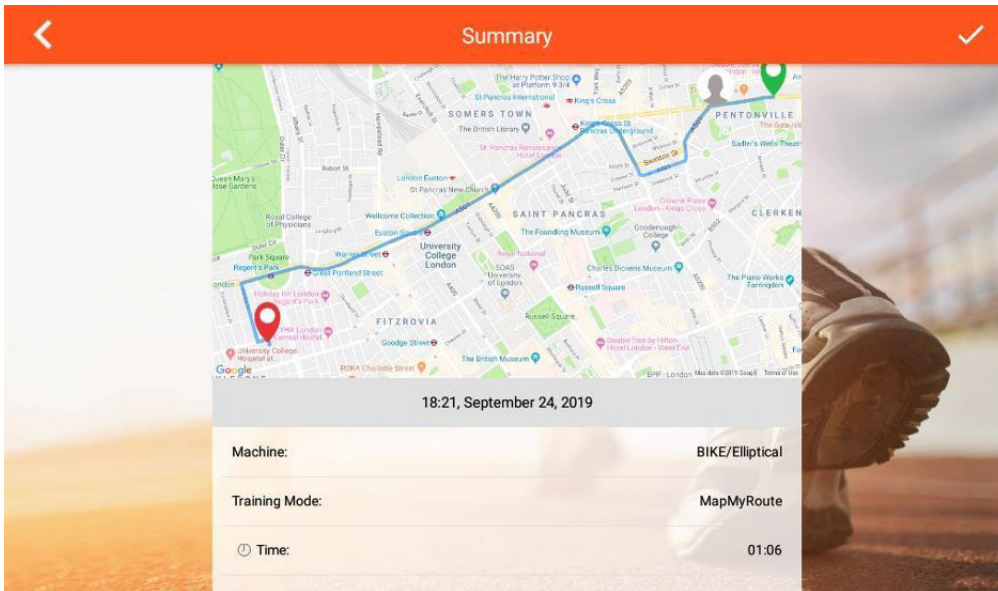
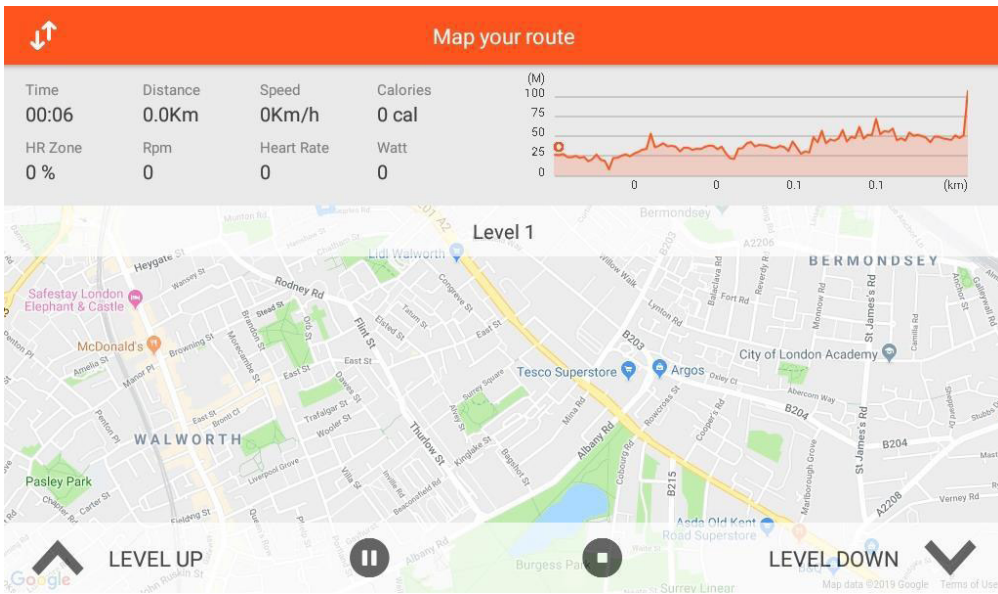

3.5 Workout tips

When training, it is important to perform the exercises correctly in order to avoid injuries and achieve the desired training effect. Make sure you use the correct technique and train at an appropriate intensity level. Always consult an expert such as a trainer or doctor if you are unsure or have health problems. Always start your training with a low load and increase it evenly and gently.

End your training with a cool-down phase. If you have any questions or uncertainties, contact your doctor.

3.5.1 Training clothes

During training, wear appropriate sports clothing that is comfortable and breathable. Avoid clothing that restricts you or is uncomfortable. Make sure that your shoes are suitable and offer you sufficient support. In addition, always carry a towel with you to wipe away sweat and keep the equipment clean.

3.5.2 Warming up and stretching

It is important to warm up and stretch properly before training to avoid injury and improve performance. Stretching helps to loosen muscles and improve flexibility. Be sure to incorporate a short stretching routine before each workout.

Warm-up exercise:

1. Stand upright with your feet about shoulder-width apart.
2. Start with gentle arm circles by slowly moving your arms forwards in small circles in a controlled manner.
3. Perform arm circles backwards to loosen your shoulders and arms.
4. Do squats by slowly squatting down and then straightening up again. Make sure that your knees do not extend beyond your toes.



CAUTION

Do not exercise with sore muscles or take it easy on the affected muscles, as this can lead to injuries.

3.5.3 Medication

If you regularly take medication and want to exercise, it is important to be aware of possible side effects. Ask your doctor whether your medication affects your workout.

3.5.4 Used muscle groups

Cycling uses the following muscle groups:

- + Gluteal muscle
- + Leg muscles

Make sure you keep your back straight during training. Do not hunch over and do not arch your back. Do not fully extend your legs, but keep a slight bend in the backwards movement.

3.5.5 Exercise frequency

Regular exercise is crucial to making progress and staying healthy in the long term. Continuous exercise can strengthen muscles, improve endurance and enhance overall well-being. Remember that even small workouts can be done regularly to achieve long-term results.

Training with heart rate orientation

Heart rate orientation guarantees an extremely effective and healthy training. Through your age and the following table, you can quickly and easily read and determine the optimal pulse for your training. An acoustic alarm will sound if your heart rate exceeds the set target heart rate. Which target heart rate is important for which training goal can be found out in the following.

Fat burning (weight management): The main goal here is to burn deposits of fat. In order to achieve this training goal, a low training intensity (approximately 55% of the maximum heart rate) and a longer training period are required.

Cardiovascular training (cardio training): The primary goal is to increase stamina and fitness through an improved provision of oxygen through the cardiovascular system. In order to achieve this training goal, medium intensity (approximately 75% of the maximum heart rate) with a medium training period is required.

Anaerobic (maximum) load training: The main goal of maximum load training is to improve recovery after short, intense loads in order to be able to quickly return to the aerobic zone. In order to achieve this training goal, a high intensity (approximately 90% of the maximum heart rate) with short, intense load is required, which is followed by a recovery phase in order to prevent muscle fatigue.







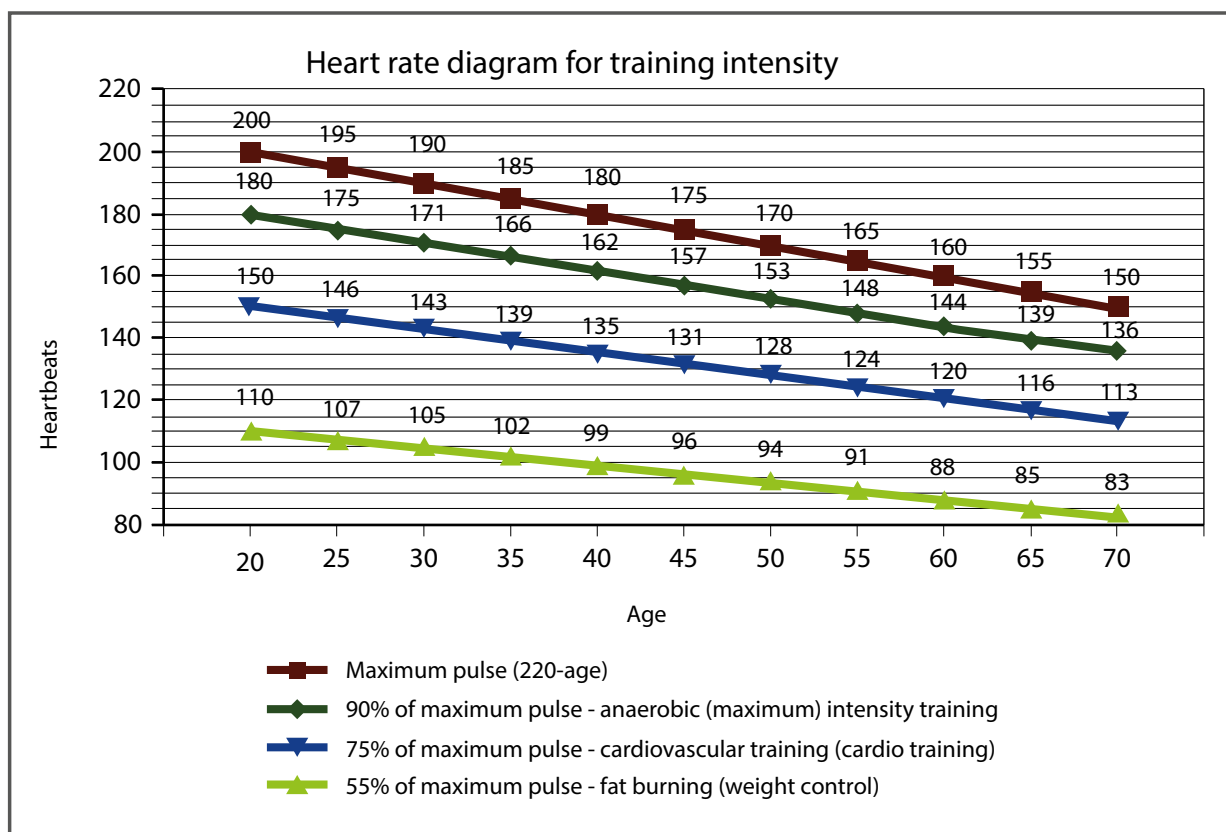

Example:

For a 45-year-old man or woman, the maximum heart rate is 175 ($220 - 45 = 175$).









- + The fat burning target zone (55%) is at approximately 96 beats/min. = $(220 - \text{age}) \times 0.55$.
- + The cardio target zone (75%) is at approximately 131 beats/min. = $(220 - \text{age}) \times 0.75$.
- + The maximum heart rate for an anaerobic load training (90%) is at approximately 157 beats/min. = $(220 - \text{age}) \times 0.9$.



3.6 Workout journal

(Copy template)

-  Date
-  Distance
-  Time (min.)
-  Resistance level
-  Training weight
-  Ø Pulse
-  Calories burnt
-  I feel ...
-  Body weight

3.7 Multimedia and Software Updates

► ATTENTION

Check your TFT-console regularly for possible software updates. If available, make sure to carry out the updates soon. If the updates are not carried out over a longer period of time, this can lead to technical problems with the console.

To make sure the pre-installed apps are working correctly, they must be updated regularly as well. Follow the instructions on the screen to perform the updates.

Please note: The system is set up only for the pre-installed apps. Do not install any additional apps as their proper functionality can not be guaranteed. The installation of other apps might cause technical issues.

ⓘ NOTICE

- + The pre-installed apps are produced and provided by external manufacturers. Changes and availability within these apps might occur. Fitshop does not take any responsibility and can not be held liable for the availability, functionality or contents of these apps.

There are a variety of apps available to you. These include:

- + Netflix
- + Youtube
- + Spotify
- + Kinomap
- + Internet browser
- + Facebook
- + Twitter
- + Instagram

You can access all of the above apps during training. You can show or hide the training parameters by tapping the following icon .

To return to the main menu, tap the following icon .

To go back one page within the apps, tap the following icon .

To start the training, tap the following icon .

To stop the training, tap the following icon .

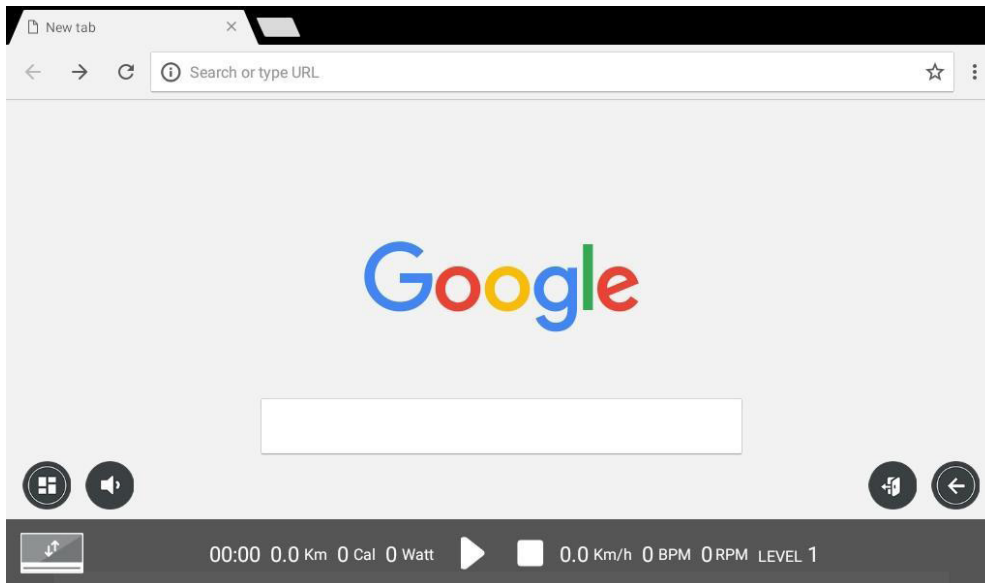

Example of an app



Overview of apps and possible software updates

4.1 General Instructions

⚠ WARNING

- + The storage location should be chosen so that improper use by third parties or children can be prevented.
- + If your equipment does not have transportation wheels, the equipment must be disassembled before transportation.

▶ ATTENTION

- + Make sure that the equipment is protected from moisture, dust and dirt in the selected storage location. The storage location should be dry and well ventilated and have a constant ambient temperature between 10°C and 35°C.

4.2 Transportation Wheels

▶ ATTENTION

If you want to transport your equipment over particularly sensitive and soft floor coverings, such as parquet, planks or laminate, lay out the transport route with cardboard or similar to avoid possible floor damage.

1. Stand behind the equipment and lift it until the weight is transferred to the transportation wheels. After that, you easily can move the equipment to a new position. For long transport distances the equipment should be disassembled and safely packed.
2. Select the new location by following the instructions in the section 1.4 of this manual.

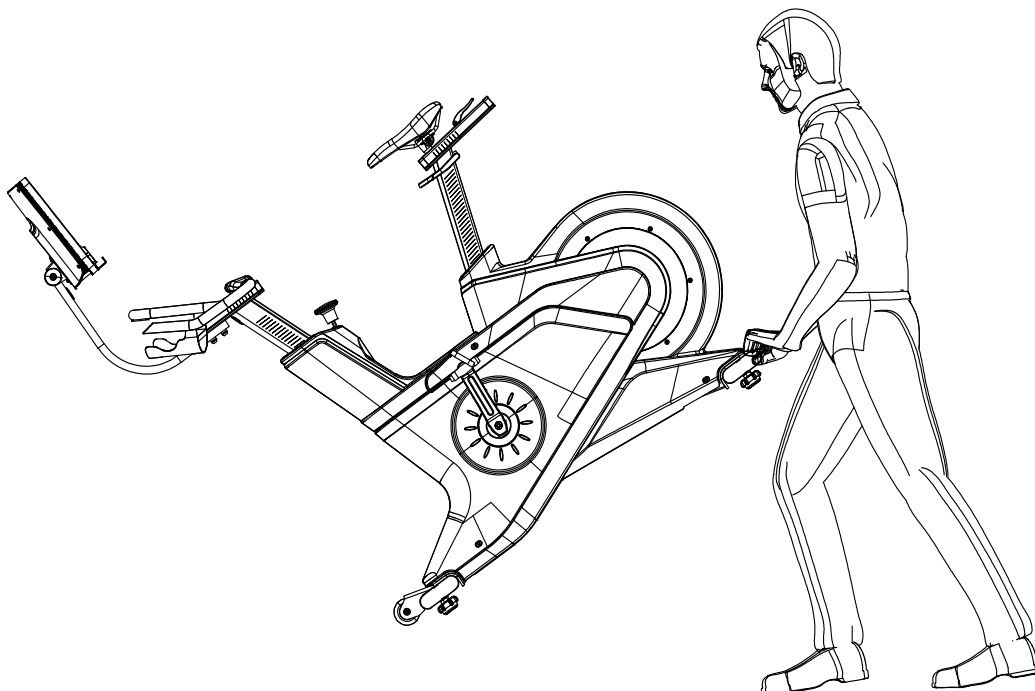

5.1 General Instructions



WARNING

- + Do not make any improper changes to the equipment.



CAUTION

- + Damaged or worn components may affect your safety and the life of the equipment. Therefore, immediately replace damaged or worn components. In such a case, contact the contract partner. The equipment must not be used until it has been repaired. If necessary, use only original spare parts.

► ATTENTION

- + In addition to the instructions and recommendations for maintenance and care given here, additional service and/or repair work may be necessary; this must only be carried out by authorised service technicians.

5.2 Faults and Fault Diagnosis

The equipment undergoes regular quality controls during production. Nevertheless, faults or malfunctions may occur. Frequently, individual parts are responsible for these disturbances, an exchange is usually sufficient. Please refer to the following overview for the most common errors and how to correct them. If the equipment still does not function properly, contact your contract partner.

Fault	Cause	Solution
Cracking in the pedal area	Pedals loose	Tighten the pedals
Equipment wobbles	Equipment is not level	Align the feet
Handlebar/saddle wobbles	Loose screws	Tighten screws firmly
Display is blank/is not working	Batteries empty or loose cable connection	Replace batteries or check cable connections
No pulse display	<ul style="list-style-type: none"> + Sources of interference in the room + unsuitable chest strap + Wrong position of chest strap + Chest strap defective or battery empty + Pulse display defective 	<ul style="list-style-type: none"> + Eliminate sources of interference (e.g. mobile phone, WLAN, lawn mower and vacuum cleaner robot, etc. ...) + Use a suitable chest strap (see RECOMMENDED ACCESSORIES). + Reposition chest strap and/or moisten electrodes + Changing batteries + Check if pulse display by hand pulse possible

5.3 Error Codes and Troubleshooting

The electronics of the equipment continuously carries out tests. In case of deviations, an error code appears on the display and normal operation is stopped for your safety.

Please contact the contract partner for technical support.

5.4 Maintenance and Inspection Calendar

To avoid damage from body sweat, the equipment must be cleaned with a damp towel (no solvents!) after each training session.

The following routine tasks must be performed at the specified intervals:

Part	Weekly	Monthly
Display console	C	I
Plastic covers	C	I
Screws and cable connections		I
Check pedals for tightness		I
Legend: C = clean; I = inspect		

6 DISPOSAL

At the end of its operational life, this equipment cannot be disposed of in normal household waste. Instead, it must be disposed of via an electricals recycling centre. Further information can be obtained from your local authority's recycling service.



The materials can be recycled as per their symbols. Through the reuse, recycling of materials or other forms of recovery of old equipment, you make an important contribution to the protection of the environment.

7 RECOMMENDED ACCESSORIES

To make your training experience even more efficient and pleasant, we recommend that you add suiting accessories to your fitness equipment. For indoor cycles this could for example be a **floor mat**, which makes your fitness equipment stand more securely and also protects the floor from sweat or **silicone spray** to keep moving parts in good shape. For many indoor bikes it is possible to replace the **saddle** or **pedals**, as these are usually the same mounts used on bicycles.

If you have purchased a fitness machine with pulse training and want to train your heart rate, we strongly recommend that you use a compatible **chest strap**, as this ensures optimum transmission of the heart rate.

Our range of accessories offers the highest quality and makes training even better. If you would like to find out more about compatible accessories, please go to the detail page of the product in our webshop (the easiest way is to enter the article number in the search field above) and go to the recommended accessories on this page. Alternatively, you can use the QR-code provided. Of course, you can also contact our customer service: by telephone, e-mail, in one of our branches or via our social media channels. We will be happy to advise you!



floor mat



chest strap



chest strap contact gel



pedals



saddle cover



silicone spray

8.1 Serial Number and Model Name

In order to provide you with the best possible service, please have the model name, article number, serial number, exploded drawing and parts list ready. The corresponding contact options can be found in chapter 10 of this operating manual.

NOTICE

The serial number of your equipment is unique. It's located on a white sticker. The exact position of this sticker is shown in the following illustration.

Enter the serial number in the appropriate field.

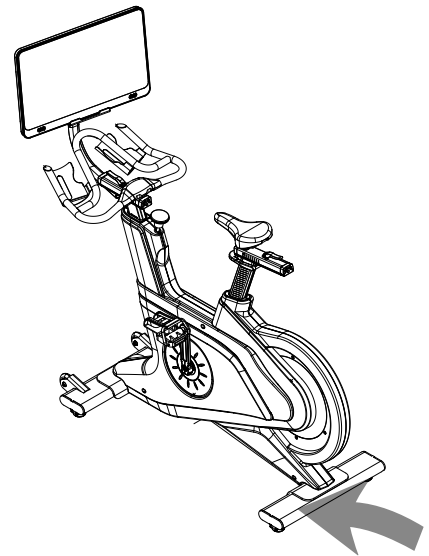

Serial number:

Brand / Category:

Model Name:

Article Number:

8.2 Parts List

No.	Name	Qty.	No.	Name	Qty.
A	Console	1	F-2	Cover for belt pulley	1
A-1	Screws	4	F-3	Screws	5
B (B-1~B-11)	Front handlebar assembly	1	F-4	Right crank	1
B-1	Handlebar	1	F-5	Hex. screw	4
B-2	Upper cover for slider	2	F-6	Nylon nut	4
B-3	Hex. Screw	5	G (G-1~G-13)	Flywheel assembly	1
B-4	Upper slider for front handlebar	1	G-1	Flywheel	1
B-5	Pull pin	1	G-2	Aluminum flywheel	1
B-6	Shaft for pull pin	1	G-3	Small belt pulley	1
B-7	Set screw	2	G-4	Axle for flywheel	1
B-8	T-shaped fixing sheet	1	G-5	Bushing	1
B-9	Briquetting for slider	1	G-6	Bearing	4
B-10	Screw	1	G-7	Bushing	1
B-11	Plastic strip for slider	2	G-8	Hex. Screw	6
C	Handlebar post	1	G-9	Nylon nut	2
C-1	Lower cover for slider	2	G-10	Fixed stick	1
C-2	Hex. Screw	2	G-11	Hex. Nut	2
C-3	Upper cable	1	G-12	Bushing	1
C-4	End plug for wire	1	G-13	Flat washer	1
C-5	Limit piece	4	H	Magnet assembly	1
D (D-1~D-2)	Console supporter assembly	1	H-1	Screws	1
D-1	Console supporter	1	H-2	Nylon nut	1
D-2	Limit block	2	H-3	Flat washer	1
E (E1~E3)	Holder tube assembly for console	1	I (I-1~I-7)	Idler wheel assembly	1
E-1	Holder tube	1	I-1	Idler lever	1
E-2	Limit block for console	2	I-2	Bearing	2
E-3	End plug for wire	1	I-3	C-type	1
F (F-1~F-6)	Belt pulley assembly	1	I-4	Flat washer	1
F-1	Belt pulley	1	I-5	Hex. Screw	1
			I-6	Hex. Nut	1
			I-7	Wave washer	1

J	Brake set	1	L-13	Gear box	1
J-1	Spring	1	L-14	Screw	4
J-2	Fixed spindle for brake	1	L-15	Adjusting lever	1
J-3	C-type	2	L-16	Nylon nut	2
K (K-1~K-14)	Brake knob assembly	1	L-17	Adjusting block for gear box	1
			L-18	Holder sheet for adjusting lever	1
K-1	Brake knob	1	L-19	Screw	1
K-2	Cover for brake knob	1	L-20	Screw	1
K-3	Brake bar	1	L-21	Right briquetting for front handlebar	1
K-4	Nylon nut	1	L-22		
K-5	Flat washer	1	L-23	Powder copper sleeve	2
K-6	Upper fixed bracket of brake	1	L-24	Lever	1
K-7	Elastic cylindrical pin	1	L-25	Screw	1
			L-26	Eccentric shaft	1
K-8	Lower fixed bracket of brake	1	L-27	Locking shaft	1
K-9	Nylon nut	1	L-28	Round flat key	1
K-10	Flat washer	1	L-29	Front sleeve	1
K-11	Flat washer	1	L-30	Rear sleeve	1
K-12	Screws	1	L-31	Shaft	1
K-13	Screws	1	L-32	Sleeve for handlebar post	1
K-14	Nylon nut	1	L-33	Brake wire	1
L	Main frame	1	L-34	Set screw	4
L-1	Left crank	1	L-35	Pedal set	1
L-2	DC wire	1	L-36	Bushing	1
L-3	Sensor holder	1	L-37	O-ring	1
L-4	Screw	4	L-38	Hex. screw	1
L-5	Sensor holder sheet	1	L-39	Hex. screw	2
L-6	Sensor box	1	L-40	Set screw	1
L-7	Left chain cover	1			
L-8	Right chain cover	1	M (M-1~M-6)	Front stabilizer assembly	1
L-9	Screws	6			
L-10	Screws	11	M-1	Front stabilize	1
L-11	Belt	1			
L-12	Down cable	1			

M-2	Transportation wheel for front stabilizer	2	P-6	Set screw	2
M-3	Cap for front stabilizer	2	P-7	T-shaped fixing sheet	1
M-4	Allen bolt	2	P-8	Briquetting for slider	1
M-5	Flat washer	2	P-9	Hex. screw	1
M-6	Nylon nut	2	P-10	Plastic strip for slider	2
N (N-1~N-2)	Rear stabilizer assembly	1	P-11	Seat	1
N-1	Rear stabilizer	1	Q (Q-1~Q-12)	Hardware set	1
N-2	Cap for rear stabilizer	2	Q-1	Hex. screw	4
O (O-1~O-17)	Seat post assembly	1	Q-2	Flat washer	4
O-1	Seat post	1	Q-3	Hex. screw	2
O-2	Pull bar	1	Q-4	Cap for screw	2
O-3	Down cover for slider	2	Q-5	Allen bolt	1
O-4	Hex. screw	2	Q-6	Nylon nut	1
O-5	Holder seat	1	Q-7	Screw	2
O-6	Limit for seat post	1	Q-8	Flat washer	2
O-7	Positioning pin for pull bar	1	Q-9	Bushing wrench	1
O-8	Positioning pin for block	1	Q-10	Wrench	1
O-9	Sleeve for pull bar	1	Q-11	Allen key	1
O-10	Spring	1	Q-12	Allen key	1
O-11	Handle positioning pin	2	R	Adaptor	1
O-12	Left pull pin for seat post	1	R-1	Power cable	1
O-13	Right pull pin for seat post	1			
O-14	Front pull pin for seat post	1			
O-15	Screw	2			
O-16	Nylon nut	1			
O-17	Screw	6			
P (P-1~P-10)	Slider assembly for seat post	1			
P-1	Slider	1			
P-2	Upper cover for slider	2			
P-3	Hex. screw	5			
P-4	Pull bar	1			
P-5	Shaft for pull bar	1			

8.3 Exploded Drawing

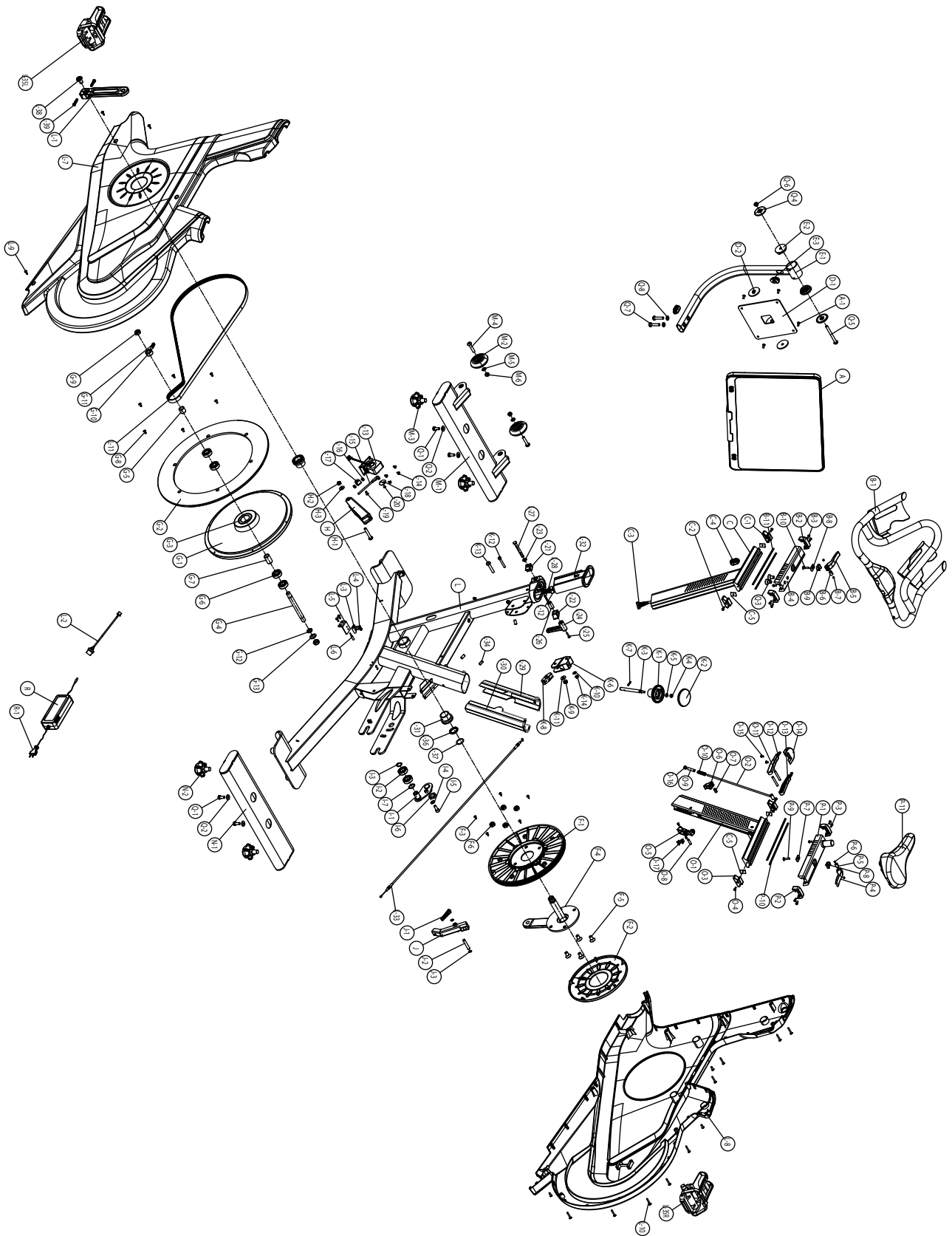

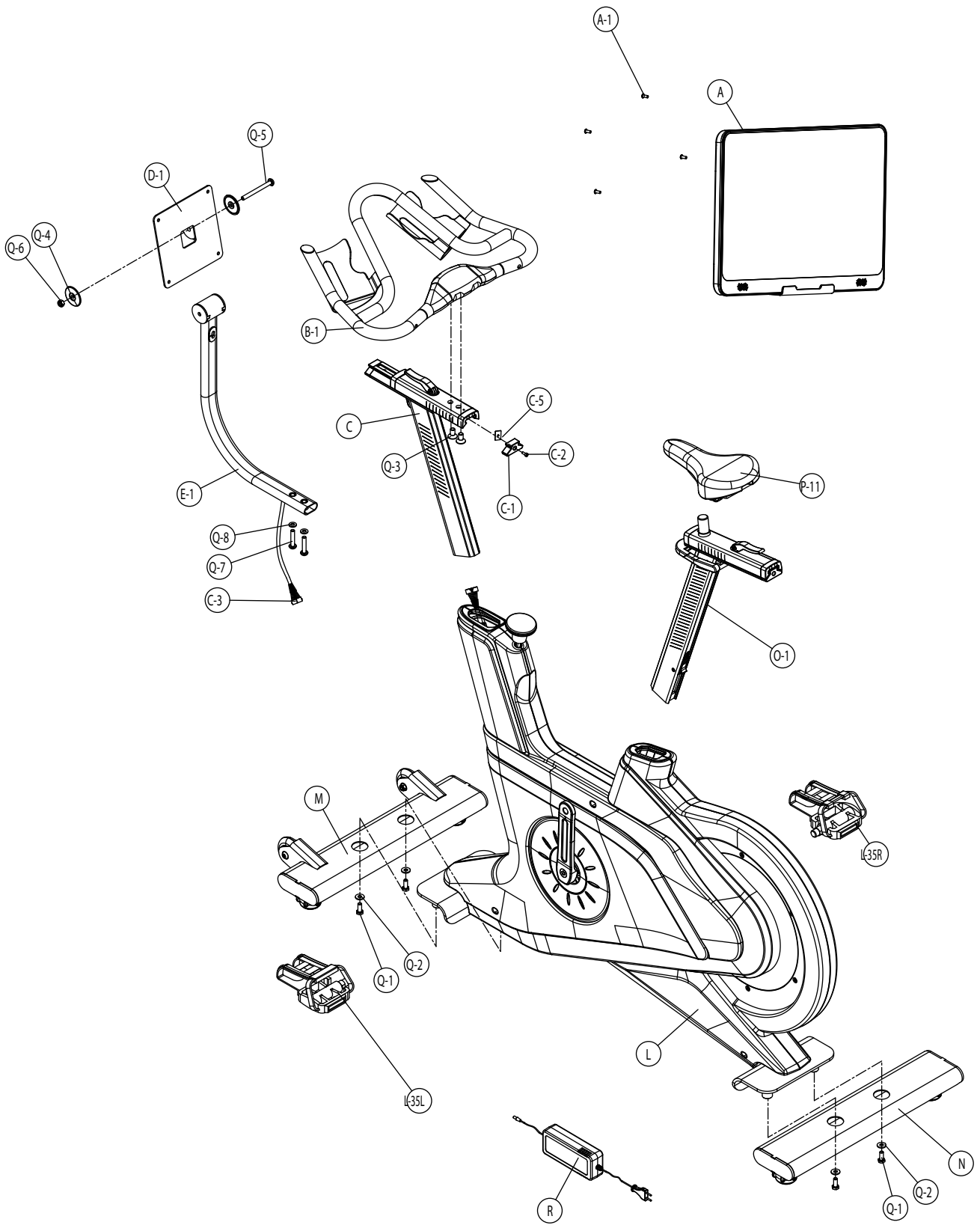

9 WARRANTY

Products from TAURUS® are subject to strict quality control. However, if a fitness equipment purchased from us does not work perfectly, we take it very seriously and ask you to contact our customer service as indicated. We are happy to help you by phone via our service hotline.

Error Descriptions

Your fitness equipment is developed for long-term, high-quality training. However, should a problem arise, please first read the operating instructions. For further assistance, please contact your contract partner or call our service hotline. To ensure your problem is solved as quickly as possible, please describe the defect as exactly as possible.

In addition to the statutory warranty, we provide a warranty for every fitness equipment purchased from us according to the following provisions.

Your statutory rights are not affected.

Warrantee

The warrantee is the first/original buyer and/or any person who received a newly purchased product as a gift from the original buyer.

Warranty period

The warranty periods, shown on our web shop, begin on delivery of the fitness equipment. The respective warranty periods for your equipment can be found on its product website.

Repair Costs

According to our choice, there will either be a repair, a replacement of individual damaged parts or a complete replacement. Spare parts, that have to be mounted while assembling the equipment, have to be replaced by the warrantee personally and are not a part of repair. After the expiration of the warranty period, the responsibility for parts costs, repair costs, installation costs and delivery costs lies with the warranty holder.

The terms of use are defined as follows:

- + Home use: solely for private use in private households up to 3 hours per day
- + Semi-professional use: up to 6 hours per day (e. g. rehabilitation centres, hotels, clubs, company gyms)
- + Professional use: more than 6 hours per day (e. g. commercial gyms)

Warranty Service

Within the warranty period, equipment which develops faults as a result of material or manufacturing defects, will be repaired or replaced at our discretion. Ownership of equipment or parts of equipment which have been replaced is transferred to us. The warranty period is not extended nor does a new warranty period begin following repair or replacement under the warranty.

Warranty Conditions

For the warranty to be valid, the following steps must be taken:

Please contact our customer service by email or phone. If the product under warranty has to be sent in for repair, the seller bears costs. After expiry of the warranty, the buyer bears the costs of transport and insurance. If the fault is covered by our warranty, you will receive a new or repaired equipment in return.

Warranty claims are invalid in case of damage resulting from:

- + misuse or improper handling
- + environmental influences (moisture, heat, electrical surge, dust, etc.)
- + failure to follow the current safety measures for the equipment
- + failure to follow the operating instructions
- + use of force (e. g. hitting, kicking, falling)
- + interventions which were not carried out by one of our authorized service centres
- + unauthorised repair attempts

Proof of Purchase and Serial Number

Please make sure that you are able to provide the appropriate receipt when claiming on your warranty. So that we can clearly identify the model of your equipment, and for the purposes of our quality control, you will need to give the serial number of your equipment, when contacting the service team. Where possible please have your serial number and your customer number ready when you call our service hotline. It will help us to deal with your request swiftly.

If you cannot find the serial number on your fitness equipment, our service team is at your disposal to offer further information.







































Service outside of the Warranty Period

We are also happy to issue an individual cost estimate if there is a problem with your fitness equipment after the warranty has expired, or in cases which do not fall under the terms of the warranty, e. g. normal wear and tear. Please contact our customer service team to find a quick and cost-effective solution to your problem. In such a case you will be responsible for the delivery costs.

Communication

Many problems can be solved just by speaking to us as your specialist supplier. We know how important it is to you as a user of the fitness equipment to have problems solved quickly and simply, so you can enjoy working out with minimal interruption. For that reason, we also want to resolve your queries quickly and in a straightforward manner. Thus, please always keep your customer number and the serial number of the faulty equipment handy.

10 CONTACT

DE	DK	UK
<p>TECHNIK</p> <p> +49 4621 4210-900</p> <p> +49 4621 4210-698</p> <p> technik@fitshop.de</p> <p> Öffnungszeiten entnehmen Sie unserer Homepage.</p> <p>SERVICE</p> <p> 0800 20 20277 (kostenlos)</p> <p> 04621 4210 - 0</p> <p> info@fitshop.de</p> <p> Öffnungszeiten entnehmen Sie unserer Homepage: https://stg.fit/statita</p>	<p>TEKNIK OG SERVICE</p> <p> 80 90 16 50</p> <p>+49 4621 4210-945</p> <p> info@fitshop.dk</p> <p> Åbningstider kan findes på hjemmesiden: https://stg.fit/statit7</p> <p>FR</p> <p>TECHNIQUE & SERVICE</p> <p> +33 (0) 189 530984</p> <p>+49 4621 42 10 933</p> <p> info@fitshop.fr</p> <p> Vous trouverez les heures d'ouverture sur notre site Internet: https://stg.fit/statit4</p>	<p>CUSTOMER SUPPORT</p> <p> 00800 2020 2772</p> <p>+494621 4210 944</p> <p> info@fitshop.co.uk</p> <p> You can find the opening hours on our homepage: https://stg.fit/statitc</p> <p>BE</p> <p>TECHNIQUE & SERVICE</p> <p> 02 732 46 77</p> <p>+49 4621 4210 933</p> <p> info@fitshop.be</p> <p> Vous trouverez les heures d'ouverture sur notre site Internet: https://stg.fit/statit8</p>
ES	NL	INT
<p>TECNOLOGÍA Y SERVICIOS</p> <p> 911 238 029</p> <p> info@fitshop.es</p> <p> Consulta nuestro horario de apertura en la página web: https://stg.fit/statit5</p>	<p>TECHNISCHE DIENST & SERVICE</p> <p> +31 172 619961</p> <p> service@fitshop.nl</p> <p> De openingstijden vindt u op onze homepage: https://stg.fit/statit3</p>	<p>TECHNICAL SUPPORT & SERVICE</p> <p> +49 4621 4210-944</p> <p> service-int@fitshop.de</p> <p> You can find the opening hours on our homepage: https://stg.fit/statita</p>
PL	AT	CH
<p>DZIAŁ TECHNICZNY I SERWIS</p> <p> 22 307 43 21</p> <p>+49 4621 42 10-948</p> <p> info@fitshop.pl</p> <p> Godziny otwarcia można znaleźć na stronie głównej: https://stg.fit/statit6</p>	<p>TECHNIK & SERVICE</p> <p> 0800 20 20277 (Freecall)</p> <p>+49 4621 42 10-0</p> <p> info@fitshop.at</p> <p> Öffnungszeiten entnehmen Sie unserer Homepage: https://stg.fit/statitb</p>	<p>TECHNIK & SERVICE</p> <p> 0800 202 027</p> <p>+49 4621 42 10-0</p> <p> info@fitshop.ch</p> <p> Öffnungszeiten entnehmen Sie unserer Homepage: https://stg.fit/statit9</p>

Please find a detailed overview including address and opening hours for all stores of the Fitshop Group in Germany and abroad on the following website:

www.fitshop.com/en/stores

WE LIVE FITNESS

WEBSHOP AND SOCIAL MEDIA

Fitshop is Europe's largest specialist store for home fitness equipment with currently over 70 stores and one of the world's most renowned online mail order companies for fitness equipment. Private customers order via the 25 web shops in the respective national language or have their desired equipment assembled on site. In addition, the company supplies fitness studios, hotels, sports clubs, companies and physio practices with professional equipment for endurance and strength training.

Fitshop offers a wide range of fitness equipment from renowned manufacturers, high-quality in-house developments and comprehensive services, such as a build-up service and sports scientific advice before and after the purchase. The company employs numerous sports scientists, fitness trainers and competitive athletes.

Visit us also on our social media platforms or our blog!

	www.fitshop.co.uk www.fitshop.de/blog
---	--

	www.facebook.com/fitshopgroup
---	--

	www.instagram.com/fitshopgroup/
---	--

	www.youtube.com/@fitshop_uk
--	--

KETTLER

TAURUS

 cardiostrong

BODYCRAFT

 cardiojump

 **DUKEFITNESS**

DARWIN

TAURUS®

Taurus Smart Bike Z9.9 Pro